

SMART WEIGHING SOLUTIONS



rinstrum

6700
Remote Display
Reference Manual

For use with Software Versions 3.1 and above

6700-600-310

TABLE OF CONTENTS

1. INTRODUCTION	3
1.1. THE MANUALS.....	3
1.2. OPERATING MODES.....	3
2. INSTALLATION.....	4
2.1. PANEL MOUNTING	4
2.2. DC POWER SUPPLY.....	4
2.3. AC POWER SUPPLY.....	4
2.4. SERIAL CONNECTIONS.....	4
3. DISPLAY AND CONTROLS.....	6
3.1. WEIGHT DISPLAY	6
3.2. UNITS INDICATOR	6
3.3. ANNUNCIATORS	6
3.4. CONTROL BUTTONS AND THE SETUP BUTTON.....	7
3.5. SETPOINTS - DIRECT OPERATOR ACCESS.....	8
3.6. DATA ENTRY MODES	8
3.7. GROUPS, ITEMS, SUBITEMS AND THE SETTING BUTTONS.....	9
4. OPERATING MODE SETUP	11
4.1. PASSCODES.....	11
4.2. ENTERING OPERATING MODE SETUP.....	11
4.3. REMOTE OPERATING MODE SETUP MENUS	12
4.4. NETWORK MASTER OPERATING MODE SETUP MENUS.....	13
4.5. SUMMING MASTER OPERATING MODE SETUP MENUS	14
5. CONFIGURING FOR REMOTE DISPLAY MODE.....	17
5.1. WIRING DIAGRAM FOR REMOTE DISPLAY MODE.....	17
5.2. CONFIGURING THE 5000 INDICATOR	17
5.3. CONFIGURING THE 6700 AS A REMOTE DISPLAY FOR A RINSTRUM INDICATOR.....	17
5.4. CONFIGURING THE 6700 AS A REMOTE DISPLAY FOR A SUPPORTED INDICATOR	17
5.5. CONFIGURING THE 6700 AS A REMOTE DISPLAY FOR OTHER INDICATORS	18
6. CONFIGURING FOR NETWORK MODE.....	24
6.1. WIRING DIAGRAM FOR NETWORK MODE.....	24
6.2. CONFIGURING THE SLAVE 5000 OR 5100.....	24
6.3. CONFIGURING THE 6700 FOR NETWORK MODE	24
7. CONFIGURING FOR SUMMING MODE	25
7.1. WIRING DIAGRAM FOR SUMMING MODE	25
7.2. CONFIGURING THE SLAVE 5000S OR 5100S	25
7.3. CONFIGURING THE 6700	25
8. GENERAL SETUP	26
8.1. PASSCODES.....	26
8.2. ENTERING GENERAL SETUP.....	26
8.3. DISPLAY OPTIONS - (OPTION).....	26
8.4. SERIAL PORTS 2 AND 3 SETTINGS (SERIAL).....	27
8.5. TEST MENU - (TEST).....	30

8.6.	SET POINTS - (SET.PTS).....	32
8.7.	ANALOGUE SETTINGS - (ANALOG).....	34
8.8.	CLOCK SETTINGS (CLOC)	34
8.9.	FACTORY ADJUSTMENT MENU - (FACTRY)	34
8.10.	LEAVING GENERAL SETUP MENUS - (-END-)	35
9.	THE SERIAL OUTPUTS	36
9.1.	SERIAL PORTS 2 AND 3	36
9.2.	NETWORK SLAVE MODE	37
9.3.	AUTOMATIC WEIGHT OUTPUT FROM THE 6700	37
9.4.	PRINTER DRIVING	40
10.	SETPOINTS	44
10.1.	INTRODUCTION	44
10.2.	THE STATUS LEDS.....	44
10.3.	CONNECTION	44
10.4.	SETTINGS	44
11.	ACCESSORIES AND OPTIONS	47
11.1.	INSTALLING OPTION CARDS.....	47
11.2.	THE SETPOINT CARD	47
11.3.	THE 'COMBO' CARD	48
11.4.	LICENSING OPTIONS	49
12.	EXTENDED FUNCTIONS	51
12.1.	INTRODUCTION	51
13.	SPECIFICATIONS.....	52
14.	ERROR MESSAGES.....	53
14.1.	CONFIGURATION ERRORS.....	53
14.2.	WEIGHING ERRORS	53
14.3.	OPERATING ERRORS.....	53
15.	ASCII CODES.....	55
16.	SETUP MENU QUICK REFERENCE.....	56

1. INTRODUCTION

The **6700** is a member of the latest generation of Ranger remote displays. The **6700** may be configured to operate as a simple remote display, a Master of the Rinstrum 5000 or a summer of several Rinstrum 5000s. The **6700** operates like a standard Rinstrum **5000** except that the weight information does not come from the load cell interface but from serially transmitted readings.

The **6700** has two full duplex communications ports and one transmit only port providing the RS232 or RS422/485 protocols. The accessory port drive either a setpoint or combination card. The setpoint card is used to drive up to 4 digital outputs and provides 4 isolated remote inputs, whilst the combination card will transmit 0..10V or 4..20mA. The **6700** is fully compliant with the provisions of technical schedule S1/0.

Configuration of the display is performed entirely from displayed prompts, with permanent storage for all setup parameters. Full specifications are covered later in this manual (Refer to Section 13).

1.1. The Manuals

The Reference Manual (this book) provides detailed coverage of the setup and operation of the Rinstrum **6700** Remote Display. It contains detailed information on the setup and configuration of the unit. This manual is intended for use by Scale Technicians who are installing the instrument. The other manuals covering the **6700** are:

- 6700 Communications Manual.

These manuals are available to download from www.rinstrum.com.

1.2. Operating Modes

1.2.1. Remote Display Mode

In this mode the **6700** operates as a remote display for a Rinstrum Indicator or another supported indicator. Weight readings are sent from the weighing indicator to the **6700** automatically and the **6700** displays the weight. The weighing indicator cannot be controlled from the **6700** in this mode.

1.2.2. Network Master Mode

Using Network Master mode, the **6700** and connected slave **5000** operate as a single unit. Pressing the ZERO, TARE or GROSS/NET keys on the **6700** is identical to performing the same operation the slave **5000**. Printing, setpointing and accessory cards are handled independently by each instrument. This arrangement makes it possible to install the **5000** close to the scale hardware, and install a **6700** in a control room to allow for remote monitoring and control. The **6700** can drive a printer where printed ticket output will be identical to the **5000** printer output.

1.2.3. Summing Master Mode

The **6700** acts as a master controller for a number of slave **5000** units connected together on a multi-drop serial RS422/RS485 bus. The **6700** polls each of the slave units and sums all of the weight readings. The resulting total weight is displayed on the **6700**. The setpointing and printing facilities and accessory cards are all driven from the total weight so the **6700** behaves like an indicator reading the total weight directly from the load cell base. The **6700** will show an error message (-----) if any of the slave weights are negative or if there is a mix of gross and net weights, as defined by Technical Schedule S/1/0A. If all slave units are showing net weight the **6700** will show a net total.

2. INSTALLATION

The **6700** can be used as either a desk-top or panel-mount display. The **6700** should be installed away from any sources of electrical noise. The communications cables should be located well away from any power or switching circuits.

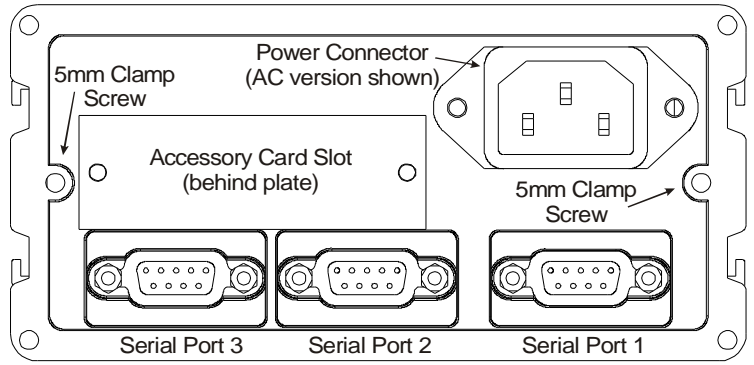

6700 Rear Plate

2.1. Panel Mounting

Panel mounting requires the optional mounting kit, consisting of a pair of clamp slides.

Remove the two 5mm clamp screws attaching the side clamp slides to the rear of the case. Remove the slides to the rear. Fit the case into the panel from the front. Replace the slides into the slots. Replace the two 5mm clamp screws. Do not over-tighten the screws as this may damage the case. An optional swivel mounting kit required for desk and wall mounting is also available.

2.2. DC Power Supply

The DC supply need not be regulated, provided that it is free of excessive electrical noise and sudden transients. The **6700** can be operated from a high quality plug-pack. The case of the **6700** should be connected to earth via the termination bolt or terminal provided.

2.3. AC Power Supply

The AC power supply for the **6700** can operate over a wide range of AC voltages. This power supply automatically adjusts to the incoming voltage, which means that the **6700** is extremely tolerant of voltage dips and brown out conditions especially when running off 220 or 240 VAC mains. The **6700** uses a standard IEC power inlet.

2.4. Serial Connections

The diagram below shows the location of the serial connections for the **6700**. Connect shield directly to the metal DB9 shell. Wiring diagrams are provided for each of the modes of operation.

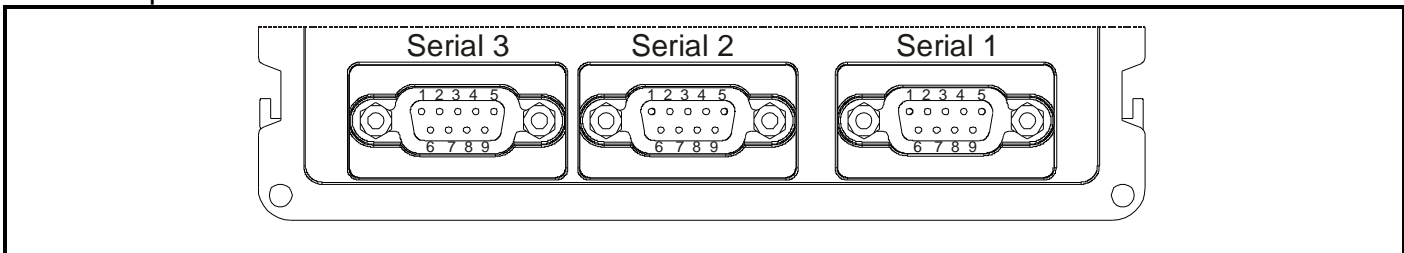

Serial 3			Serial 2			Serial 1		
P	Name	Function	P	Name	Function	P	Name	Function
2	NC		2	RXD	RS232 Receive	2	RXD	RS232 Receive
3	TXD	RS232 Transmit	3	TXD	RS232 Transmit	3	TXD	RS232 Transmit
4	DTR	Data Terminal Ready	4	DTR	Data Terminal Ready	4	NC	
5	GND	RS232 Ground	5	GND	RS232 Ground	5	GND	RS232 Ground
6	NC		6	RX-	RS422 Receive-	6	RX-	RS422 Receive-
7	NC		7	RX+	RS422 Receive+	7	RX+	RS422 Receive+

8	TX-	RS422 Transmit-	8	TX-	RS422 Transmit-	8	TX-	RS422 Transmit-
9	TX+	RS422 Transmit+	9	TX+	RS422 Transmit+	9	TX+	RS422 Transmit+

3. DISPLAY AND CONTROLS

The front panel of the **6700** has five main display sections. Each of these is shown on the diagram below. An explanation of each is also provided.

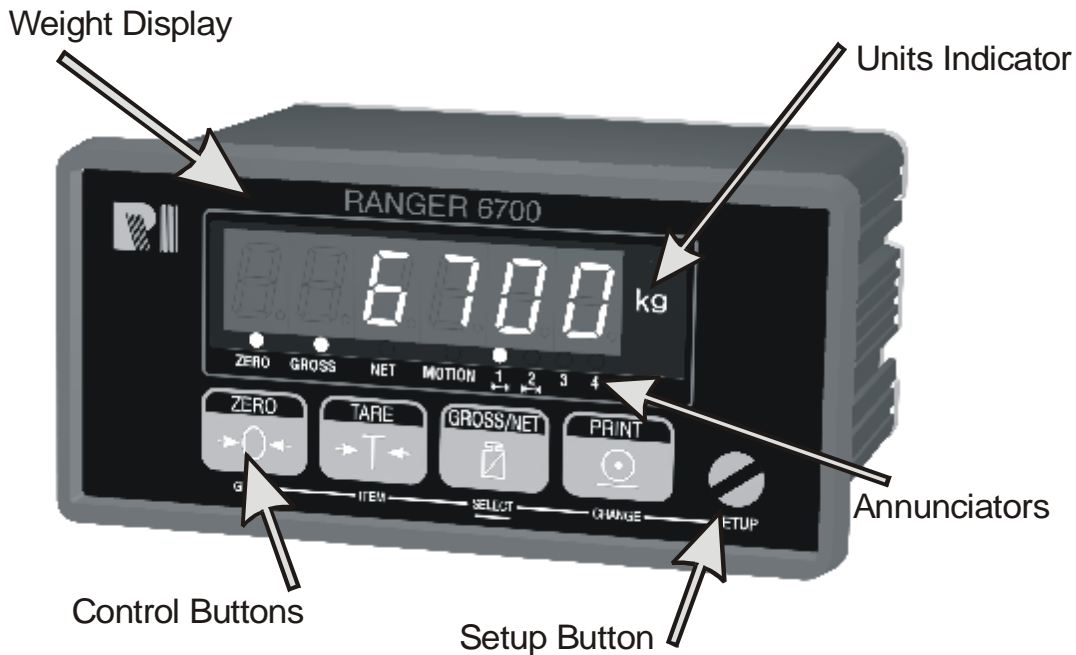

3.1. Weight Display

Displays the weight readings and setup information.

3.2. Units Indicator

The unit indicator displays the units for the weight reading as one of the following: grams (g), kilograms (kg), pounds (lb) or tonnes (t). In Network Master mode, the units are retrieved from the remote unit. For remote display and summing mode, the units are set via the **6700** menus.

3.3. Annunciators

The annunciator bank made up of two groups of four LEDs. The status set (3) show the status of the displayed reading.

The function of the number set (4) depends on the type of data being displayed. If the incoming data is from an indicator operating in dual interval or dual range mode they show which range the data is in. Otherwise they show the status of the 4 setpoints.

Annunciator	Meaning
ZERO	Lit when the displayed reading is within $\pm \frac{1}{4}$ of a division of true zero.
GROSS	Lit when the display reading represents GROSS weight.
NET	Lit when the display reading represents NET weight.
MOTION	Lit when the displayed reading is not stable.
1,2,3,4	Lit to indicate when a set point output is active. In multi-range mode these show which range is active.

3.4. Control Buttons and the Setup Button

The **6700** has five front panel buttons that control the operation of the instrument. The four main buttons are visible on the front panel. The fifth button (SETUP) is hidden behind a security screw at the right. The security screw can be sealed to prevent unauthorised tampering with the setup of the **6700**.

Each of the four main buttons have two separate functions:





- a Primary Function that is available during normal operation - this function is printed in white at the top of the button. The primary functions of each button are described below.
- a Secondary Function which is available during setup - this function is printed beneath the button. Secondary functions of each button are described in Section 3.6.

3.4.1. Primary Functions

In basic weighing mode, the **6700** acts as a simple weight readout with optional printing and serial output capability. Depending on the operating mode of the **6700** each button triggers the weighing operation printed on it.

The **6700** allows individual buttons to be disabled in the setup. All buttons are enabled at the factory, but some buttons may have been intentionally disabled during installation. If a button beeps to acknowledge the press, but does not appear to trigger the desired action, this may be due to three possible causes:

- The button has been disabled in setup;
- The weight is outside of limits permitted for that button operation;
- The operation is being blocked by motion in the scale weight.

Button	Function
<p>Zero</p> 	<p>This button is used with Network and Summing Master operation to issue a ZERO command to the slave 5000 indicator(s). It has no effect when operating as a remote display.</p>
<p>Tare</p> 	<p>With Network and Summing Master modes this button is used to send a TARE command to the slave 5000(s). This button has no effect if the 6700 is operating as a remote display.</p> <p>A two second press on the Tare button accesses the pre-tare entry and trip-point settings on installations when setpointing is used.</p>
<p>Gross/ Net</p> 	<p>This button is used with Network and Summing Master operation to issue a GROSS/NET command to the slave 5000(s) which toggles between Gross weight and Net weight. This button has no effect if the 6700 is operating as a remote display.</p> <p>A two second press of the Gross/Net button provides quick access to the current operating mode menus. A password may be entered to restrict access to this feature, see Section 4.1.</p>
<p>Print</p> 	<p>If a printer or computer has been attached to the 6700 and the manual print function selected, the Print button will trigger an output of the current weight reading.</p>

3.4.2. Stability Considerations

Once a Zero, Tare or Print button is pressed the unit waits for a stable valid reading before performing the associated operation. If the weight readings remain unstable or invalid due to a Diagnostic Error for longer than 5 seconds the operation is canceled and an error message is displayed.

3.5. Setpoints - Direct Operator Access

The **6700** can drive up to four set points. The status of the outputs is displayed on the “1, 2, 3 and 4” lamps in the display. If a lamp is ON, the corresponding output is energised. Note that in multi-range applications that these lamps are used to indicate the current range, and do not show the setpoint status.

The trip values (Target and Flight) of these setpoints can be accessed directly by pressing the TARE (**ITEM**) button for 2 seconds. Full access to all setpoint configuration options is only possible through the digital setup menus. See Section 8.6 for details.

Use the following procedure for direct operator changes to setpoint trip values:

- Press **ITEM** for 2 seconds to enter the Setpoint Operator Setup.
- Press **ITEM** to select an item from Targets (Target), Inflight (FLT) and Pretare (Pre.Tar).
- Press **SELECT** to view the subitems from the item selected.
- Use the **SELECT** to choose an item to view or edit.
- Use the **SELECT** and **CHANGE** buttons to edit the value shown.
- Press **ITEM** to save changes.
- Press **GROUP** to return the **6700** to weighing mode. Any new values entered will be used immediately.

3.6. Data Entry Modes

Throughout the **6700** operator interface, a number of data entry methods are used. Each method and its operation is described below.

3.6.1. Numeric Entry



A numeric entry box allows the input of a number. When entering a number the display will show the number as “000000”, with the currently active digit flashing. The **CHANGE** key cycles through 0 to 9. Pressing the **SELECT** key moves the active digit, cycling from right to left. Pressing the **ITEM** key accepts the number, whilst holding **GROUP** will escape from number editing without saving the changes.

Upper and lower limits are placed on some entries and an entry outside this range will cause the **6700** to display “-----“, and resume number editing.

3.6.2. Selections



A selection entry requires the choice of a single item from a list of options. The currently selected item is displayed, and **CHANGE** key can be used to switch between the available options. Pressing the **SELECT** key will select the current item, whilst holding the **GROUP** key for two seconds will abort the selection, and revert to the original item.

3.6.3. Alpha-numeric Entry



An alpha-numeric entry allows the input of data strings. The **6700** will display the string in either of the following formats “01.065” or “01.'A'”. The first format is [PP.CHR], where PP is the position in the string, and CHR is the ASCII number of the character. The latter format is essentially the same as the first format, however CHR displays the actual character. Not all characters can be displayed, and the display will revert to the first format if the character cannot be displayed. Note that 255 is largest number that can be entered for a character. Below is a table describing the keystrokes for the alpha-numeric entry.

Common Functions			
Function	Action 1	Action 2	Action 3
Next Position	Press ITEM		
Insert Character	Hold SELECT Displays 'INS'	Press SELECT	
Delete Character	Hold SELECT Displays 'INS'	Press CHANGE Displays 'DEL'	Press SELECT
Switch Display	Hold CHANGE		
Save String	Press GROUP		

Number Display (01.065) Mode			
Function	Action 1	Action 2	Action 3
Next Digit	Press SELECT		
Modify Digit	Press CHANGE		

Character Display (01.'A') Mode			
Function	Action 1	Action 2	Action 3
Change Character	Press CHANGE		

3.6.4. Options



An option entry allows the selection of an option for a number of settings. Typically these items are on/off items, however more than two options are available in some cases. For example, the **6700** serial settings are configured via an option entry, as shown below. The currently selected item will flash, and may be changed by using the **CHANGE** key. Press the **SELECT** key to advance to the next item. Pressing the **ITEM** key will accept the current settings for all options shown.

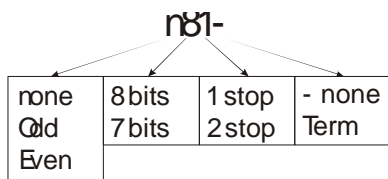

3.7. Groups, Items, Subitems and the Setting Buttons

The **6700** setup menus are organised in a tree structure made up of **Groups** and **Items**. The following notation is used throughout the manual to identify the location of an item: (GROUP:ITEM).

Groups (GROUP)

Digital Setup is divided into a series of “Groups”. Each group has a distinctive group title. All items in any one group have related functions. The **GROUP** key can be used to scroll through the available groups. Pressing the **ITEM** key will enter the selected group, allowing access to the items within the group.

Items (ITEM)

Each group is divided into numbers of individual “Items”. Each item represents a parameter that can be changed, or a sub menu. The **ITEM** key will advance through the list. Press the **SELECT** key to edit the item, or advance to the sub menu.

Select (SELECT)

The next level consists of editing an item, or a layer of sub-groups.

4. OPERATING MODE SETUP

Setup of the **6700** is divided into two sections. The first section covered here involves the setup of the **6700** operating mode. The second section, known as "GENERAL" setup, covers the setup of other features, not directly associated with a particular operating mode. General setup is covered in Section 8.

4.1. Passcodes

The **6700** uses a passcode to provide a security lock on all setup menus. Passcodes can be set from the menu item (OPTION:PASSCD). A setting of "000000" clears the passcode and allows free access to Digital Setup. This is the default setting and must be changed by the installer to restrict operator access. Any other number will enable the passcode function and restrict access to the setup menus. When a passcode is enabled, the **6700** will prompt for passcode confirmation before entering Digital Setup. A value of 000000 will be displayed, and the correct passcode must be entered, in the standard numeric entry fashion. Correct entry of the code will allow access to Setup, whilst an incorrect passcode will trigger an error message and the display will return to the normal weight display. The passcode must not be forgotten, as it is only possible to circumvent it at the factory. Care must be taken with the use of the passcode to ensure that the instrument does not become permanently locked.



4.2. Entering Operating Mode Setup

There are two ways to access the **6700** Operating Mode Setup, both of which are discussed below.

SETUP



Method 1: To enter Operating Mode Setup, remove the security screw and press the button behind it. The **6700** will display "SERIAL SETUP 6700", followed by the software version. If a passcode has been configured, it must be entered to gain access to setup. The **6700** will then prompt for the access mode. The available options are:

- Remote Display Mode (rEmOtE) (See Section 4.3)
- Network Master Mode (nEt.m) (See Section 4.4)
- Summing Master Mode (SUm.m) (See Section 4.5)

Use the **CHANGE** key to select the desired mode, and the **SELECT** key to accept it. If the mode has changed, the **6700** will prompt to continue. Upon selecting a mode, the **6700** will automatically configure some settings to suit the application, and then enter the operating mode setup menus.



Method 2: When no alteration of the operating mode is required, Quick Setup will enter the Operating Mode Setup without prompting to change the operating mode. Quick setup can be accessed by holding the GROSS/NET key for two seconds. The **6700** will display "SERIAL SETUP 6700", followed by the software version. If a passcode has been configured, it must be entered to gain access to setup. The **6700** will then enter the Operating Mode Setup. No defaults are configured when entering setup via this method.

4.3. Remote Operating Mode Setup Menus

The options in this section apply to Remote Operating Mode only.

4.3.1. Indicator Brand - (BRAND) SEL

Preconfigures the remote display for a particular indicator. Choose the brand of indicator to preconfigure it with. The formats are listed in Section 5.4.

4.3.2. Serial Port Settings (SERIAL)

Items within this Group are used to configure the primary serial port of the 6700 remote display.

(SRC) Data Source SEL

The 6700 can accept data on serial port 1 in the following formats: RS232 and RS422. This option selects the data source. The Scan option causes the display to scan each source for data in the following order (RS232, RS422).

Options: RS232, RS422, Scan. Default: Scan.

(BAUD) Baud Rate SEL

The baud rate item determines the serial data transmission/reception speed for the primary serial port. The AUTO setting causes to the unit to attempt to determine the baud rate and bit pattern automatically.

Options: 300, 600, 1200, 2400, 4800, 9600, 19200, AUTO. Default: AUTO.

(Bits) Serial Format Options OPT

The bits options allow the data transmission bit pattern to be changed. The display will show the current setting in the form (n81T) where each character has a meaning as shown below. If the Baud Rate is set to AUTO, the bit format also automatically determined, and this item has no effect. Available options are:

- n,O,E: Parity bit
- 8, 7: The number of data bits
- 1, 2: The number of stop bits
- , T: Termination resistors

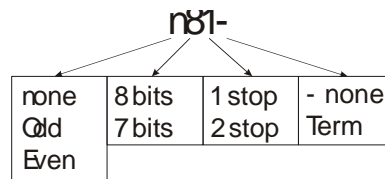

Default: n81-. For most applications the default setting is applicable.

(ADDR) Serial Address 123

Sets the serial address for the secondary serial port.

Can be set from 00 to 99.

4.3.3. Display Options - (OPTION)

Items within this Group are used to configure the 6700 display.

(TIMEO) Data Time Out SEL

Sets the period of time the unit waits from the last valid message, before displaying an error message.

Options: NoTimeout, 5, 10, 20. Default: 5.

(UNITS)**Display Units**

Selects the units to be displayed.

Options: g (grams), kg (kilograms), lb (pounds), t (tonnes). Default kg.

4.3.4. Remote Format Blocks - (BLOCK)

Items within this group control settings associated with the use of Remote mode.

(BLK 1 .. Blk 4) Data Format Blocks

The data format blocks are strings containing tokens, used to interpret an incoming data stream. The tokens are specified in the table in Section 5.5.6. Five format strings are provided, the first being fixed to Ranger Auto Format A. However, the remaining four strings are user programmable. The parser attempts to match incoming data to any of the enabled data formats (see BLOCK:ENABLE for enabling data formats). The last character in a format string should be the end of transmission (ETX) character. Typical examples of an ETX character are ETX (ASCII 3), Carriage Return (ASCII 13) and Line Feed (ASCII 10). This should be followed by a 0 to terminal the parsing string.

Default: Ranger Format C (FMT1), Ranger Format D (FMT2), Ranger Format E(FMT3) and Avery L130 (FMT4).

(ENABLE) Format Enables

Individually enables each of the five format strings.

Default: R1234.

(PRESET) Standard Data Formats

Preconfigures a specific data format block with a standard format string. First, enter which format block to preconfigure (1..4 corresponding to BLOCK:BLK1..BLOCK:BLK4) and then choose the format string to preconfigure it with. The formats are listed in Section 5.4.

(RESET) Reset Formats to Defaults

Resets all four format blocks (BLOCK:BLK1-BLOCK:BLK4) back to factory defaults. Prompts ConT Y / ConT N before performing the reset.

4.3.5. Leaving Remote Operating Mode Setup Menus - (-END-)

To exit setup and return to normal operation, press the **GROUP** key until the **-END-** group header appears in the display. Then press the **ITEM** button to exit the setup. The **6700** will display "Saving" before returning to normal operation.

4.4. Network Master Operating Mode Setup Menus

The options in this section apply to Network Master Operating Mode only. Note that Network Master mode is a software option, and may not be available on some units. Please refer to Section 11.4 for information regarding software options.

4.4.1. Display Options - (OPTION)

Items within this Group are used to configure the **6700** display.

(TIMEO)

Data Time Out



Sets the period of time the unit waits from the last valid message, before displaying an error message.

Options: NoTimeout, 5, 10, 20. Default: 5.

4.4.2. Serial Port 1 Settings (SERIAL)

Items within this Group are used to configure the primary serial port of the 6700 remote display.

(SRC) Data Source



The 6700 can accept data on serial port 1 in the following formats: RS232 and RS422. This option selects the data source. The Scan option causes the display to scan each source for data in the following order (RS232, RS422).

Options: RS232, RS422, Scan. Default: RS232.

(BAUD) Baud Rate



The baud rate item determines the serial data transmission/reception speed for the primary serial port. The AUTO setting causes to the unit to attempt to determine the baud rate and bit pattern automatically.

Options: 300, 600, 1200, 2400, 4800, 9600, 19200, AUTO. Default: 9600.

(Bits) Serial Format Options



The bits options allow the data transmission bit pattern to be changed. The display will show the current setting in the form (n81T) where each character has a meaning as shown below. If the Baud Rate is set to AUTO, the bit format also automatically determined, and this item has no effect. Available options are:

- n,O,E: Parity bit
- 8, 7: The number of data bits
- 1, 2: The number of stop bits
- , T: Termination resistors

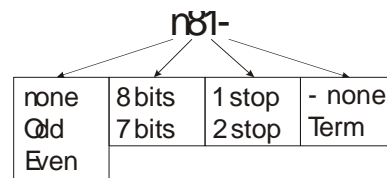

Default: n81-. For most applications the default setting is applicable.

4.4.3. Leaving Network Master Operating Mode Setup Menus - (-END-)

To exit setup and return to normal operation, press the **GROUP** key until the **-END-** group header appears in the display. Then press the **ITEM** button to exit the setup. The 6700 will display "Saving" before returning to normal operation.

4.5. Summing Master Operating Mode Setup Menus

The options in this section apply to Summing Master Operating Mode only. Note that Summing Master mode is a software option, and may not be available on some units. Please refer to Section 11.4 for information regarding software options.

4.5.1. Display Options - (OPTION)

Items within this Group are used to configure the 6700 display.

(SLAVES) Number of Slave Devices

Selects the number of slave devices to sum when operating in Ranger Network Summing mode. Refer to Section 7 for information on this type of operation. For other types of display operation, this option has no effect.



Can be set from 1 to 10. Default: 1.

(TIMEO) Data Time Out

Sets the period of time the unit waits from the last valid message, before displaying an error message.



Options: NoTimeout, 5, 10, 20. Default: 5.

(UNITS) Display Units

Selects the units to be displayed.



Options: g (grams), kg (kilograms), lb (pounds), t (tonnes). Default kg.

4.5.2. Serial Port 1 Settings (SERIAL)

Items within this Group are used to configure the primary serial port of the 6700 remote display.

(SRC) Data Source

The 6700 can accept data on serial port 1 in the following formats: RS232 and RS422. This option selects the data source. The Scan option causes the display to scan each source for data in the following order (RS232, RS422).



Options: RS232, RS422, Scan. Default: RS422.

(BAUD) Baud Rate

The baud rate item determines the serial data transmission/reception speed for the primary serial port. The AUTO setting causes to the unit to attempt to determine the baud rate and bit pattern automatically.



Options: 300, 600, 1200, 2400, 4800, 9600, 19200, AUTO. Default: 9600.

(Bits) Serial Format Options

The bits options allow the data transmission bit pattern to be changed. The display will show the current setting in the form (n81T) where each character has a meaning as shown below. If the Baud Rate is set to AUTO, the bit format also automatically determined, and this item has no effect. Available options are:



- n,O,E: Parity bit
- 8, 7: The number of data bits
- 1, 2: The number of stop bits
- , T: Termination resistors

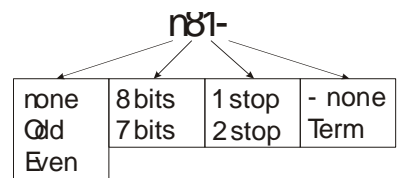

Default: n81-. For most applications the default setting is applicable.

4.5.3. Leaving Summing Master Operating Mode Setup Menus - (-END-)

To exit setup and return to normal operation, press the **GROUP** key until the **-END-** group header appears in the display. Then press the **ITEM** button to exit the setup. The **6700** will display "Saving" before returning to normal operation.

5. Configuring for Remote Display Mode

The **6700** is designed to primarily operate as a remote display. Remote Display mode provides a token based data interpreter. The unit provides standard Ranger formats to simplify connection to Rinstrum indicators. In addition a number of common indicators are also supported. Attaching the unit to other non-supported indicators and data sources requires manual configuration of the format strings.

Five formats are provided for interpreting data streams. The first of these is always configured for Ranger Standard Format (5000 Standard Auto Format A) and cannot be altered. The remaining four default to Ranger Standard Format C, Ranger Standard Format D, Ranger Standard Format E and Avery L130.

5.1. Wiring Diagram for Remote Display Mode

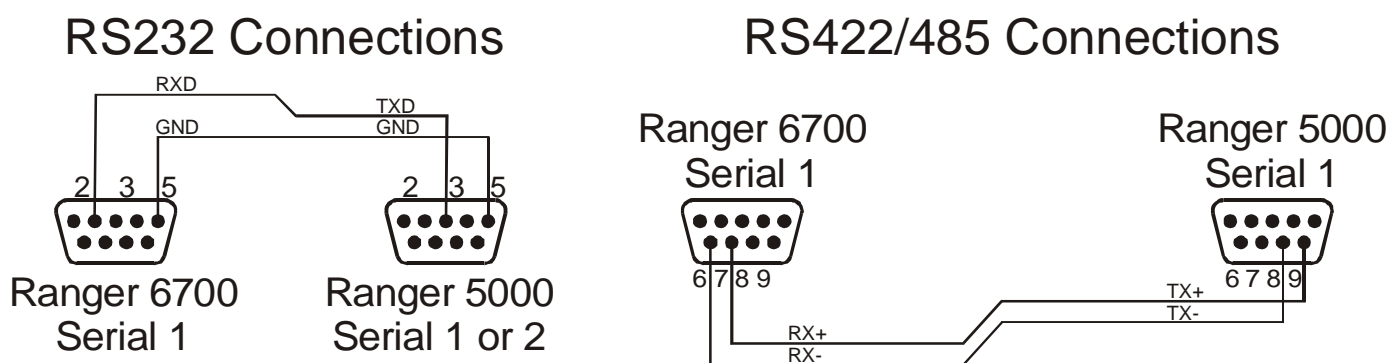

5.2. Configuring the 5000 Indicator

For remote display operation configure the weighing indicator to transmit in 'Auto Output' mode. In the case of the **5000** either serial 1 or serial 2 can be used for this task and the communications can be RS232 or RS422/RS485.

5.3. Configuring the 6700 as a Remote Display for a Rinstrum Indicator

Configure the Rinstrum Indicator (**5000 / 5100**) for either Auto Output Format A or Auto Output Format C. Note that Format C provides Center of Zero, in addition to other status. Once the indicator is configured, perform the following steps:

- Enter the Operating Mode Setup menus (Press the Setup Key);
- Remote mode is default, set it if not.
- Set the weight units to be displayed (OPTION:UNITS);
- Data Source (SERIAL:SRC) defaults to SCAN, set if required;
- Baud Rate (SERIAL:BAUD) defaults to AUTO, set if required;
- Serial Format (SERIAL:BITS) default to n81, set if required.

5.4. Configuring the 6700 as a Remote Display for a Supported Indicator

The **6700** stores a number of formats to support both Rinstrum and non-Rinstrum Indicators. The list of supported indicators is given below.

Name	Indicator	Name	Indicator
RngerA	Ranger Auto Output A	AD EP	A&D EP
RngerC	Ranger Auto Output C	AD4531	A&D AD4531
RngerD	Ranger Auto Output D	AD HV	A&D HV
RngerE	Ranger Auto Output E	TOLEDO	Toledo
AvL130	Avery L130	AVERY	Avery (L105/L200)
GDG C2	Gedge C2	BARLO	Barlo
GDG C3	Gedge C3	PHLPS	Phillips 1577, 1627
AD 1	A&D	LODEC	Lodec

To configure the display for one of the indicators, follow the steps below:

- Enter the Operating Mode Setup menus (Press the Setup Key);
- Remote mode is default, set it if not.
- Set the weight units to be displayed (OPTION:UNITS);
- Data Source (SERIAL:SRC) defaults to SCAN, set if required;
- Baud Rate (SERIAL:BAUD) defaults to AUTO, set if required;
- Serial Format (SERIAL:BITS) default to n81, set if required;
- Select the Indicator from the BRAnD menu item.

5.5. Configuring the 6700 as a Remote display for Other Indicators

If the indicator is not covered in the list of supported indicators, it is possible to construct a custom format string to support the indicator. Prior to constructing the format string, the following steps should be taken:

- Enter the Operating Mode Setup menus (Press the Setup Key);
- Remote mode is default, set it if not.
- Set the weight units to be displayed (OPTION:UNITS);
- Data Source (SERIAL:SRC) defaults to SCAN, set if required;
- Baud Rate (SERIAL:BAUD) defaults to AUTO, set if required;
- Serial Format (SERIAL:BITS) default to n81, set if required;
- If messages are not sent regularly, set the timeout (OPTION:TIMEO) to NO.TMO.

Having carried out the steps above, the following sections describe the procedure to configure the 6700 for the indicator. An example (a 5000 indicator, with auto output format C) is given throughout.

5.5.1. Determining the Serial Format from the Indicator

It is important to know the exact format of the data being sent from the indicator. Without this, it is impossible to construct a format string. There are a number of ways to determine this string:

- From the indicator's manual;
- Using a terminal program on a PC to capture the data stream.

Example:

From the 5000 reference manual, Format C is described as:

```
STX Sign Weight(7) S1 S2 S3 S4 Units(3) ETX
```

Where

STX is the Start of Transmission Character (ASCII 2)

Sign is '-' or space

Weight is a 7 character field, with leading spaces

S1 is status G/N/O/U/E meaning Gross/Net/Overload/Underload/Error
 S2 is status M/Space meaning Motion/Stable
 S3 is status Z/Space meaning Center Of Zero/Non Zero
 S4 is range status
 Units is a 3 character field
 ETX is the End of Transmission Character (ASCII 3)

Some examples of this string would be ('_' represents a space):

```
(STX) - _ _ _ 1 2 3 4 G M _ K g _ (ETX)
(STX) - _ _ _ _ _ _ 0 G _ Z K g _ (ETX)
(STX) - _ _ _ _ 1 . 3 4 N _ Z K g _ (ETX)
```

5.5.2. Determining the End of Transmission Character

The 6700 requires an End of Transmission Character to locate a reference position within a data stream. Typical examples of End of Transmission Characters are CR (Carriage Return), LF (Line Feed) and ETX. However any ASCII character may be used, on the proviso that it occurs only once and at the end of the serial string.

Example:

The ETX character (ASCII 3) is to be used as the End of Transmission character.

5.5.3. Identifying Elements in the Data Stream

From the serial string it is necessary to identify the following items, which the display will recognise:

- A field to display, matching these parameters:
 - Can be either text or number;
 - Field must be less than 9 characters wide
 - Only six characters excluding leading zeros and spaces can be displayed.
- Any status flags to recognised by the display. These include:
 - Center of zero;
 - Motion / Stable;
 - Gross / Net;
 - Errors / Overload / Underload.
- Other data in the stream that is not required by the display

Example:

STX	Sign Weight(7)	S1	S2	S3	S4	Units(3)	ETX
I	Field (8 Chars)	S	M	C	I	Ignore	E
g		t	o	O	g		T
n		a	t	Z	n		X
o		t	i		o		
r		u	o	(Z	r		
e		s	n	/'')	e		
		(G	(M				
		/N	/'')				
		/O					
		/U					
		/E)					

In the example, the STX character is not required, and can be ignored. The sign and seven weight characters can be grouped into a field of 8 characters. Following the field are status flags for Status, Motion, Center of Zero. The fourth status flag for range

is not handled by the display, and is therefore ignored. Likewise the units are not handled by the display and must also be ignored. The ETX character ends the string, as identified in the section above.

5.5.4. Selecting Tokens for Each Element

Using the items identified within the serial string above, formatting and parsing tokens from the list in Section 5.5.6, can now be chosen. If a token does not match the item exactly, a token of similar nature may surface. For example, if a status field in a data stream contained E/O/U, the token for G/N/O/U/E (181) could be used. Alternatively if no suitable token can be found, that item could be ignored.

Example:

For each item in the data stream a token is chosen, as shown below.

STX	Sign Weight(7)	S1	S2	S3	S4	Units(3)	ETX
I	Field (8 Chars)	S	M	C	I	Ignore	E
g	(167)(170)	t	o	O	g	(132)	T
n		a	t	Z	n		X
o		t	i	(Z	o		(03)
r		u	n	r	e		
e		s	n	(188)	(130)		
(130)		(G	(M				
		/N	/')				
		/O					
		/U	(184)				
		/E)					
		(181)					

Combine to (133)

Thus the format string becomes:

130 167 170 181 184 188 130 132 003

Note that some simplifications can be performed. The width of the string is 8 characters using token 167 which is the default and can therefore be removed. In addition we need to ignore the S4 status and three units characters, a total of four characters. Thus the two ignore tokens (130 and 132) can be combined into the ignore four characters token (133). Thus the final string becomes:

130 170 181 184 188 133 003 000

Note that the 000 has been added to the end of the string. It is required to inform the parser that no further parsing should take place.

5.5.5. Assembling and Entering the Format String

The format string is now finalised and can now be entered into the display. Choose one programmable format (BLOCK:BLK1 .. BLOCK:BLK4) of the Operating Mode menus, and enter the format, as per normal string entries (Section 3.6.3). Once entered, ensure the selected format is enabled from (BLOCK:ENABLE) of the

Operating Mode menus. Exit the menu system and the display should show the weight on the indicator.

5.5.6. Format and Parsing Tokens

Following is a table of all of the tokens. Note the distinction between Parsing and Formatting Tokens.

- Formatting Tokens simply specify characteristics of a field that a parsing token later in string will use whilst processing the data stream. Formatting Tokens do not use any characters from the incoming data stream.
- Parsing Tokens process the data in the data stream.
- Display Tokens change formatting of fields for displaying purposes.

The Uses column specifies the number of characters a token uses from the incoming data stream.

Ignore Character Parsing Tokens		Uses	Parsing
130	Skip 1 character	1	
131	Skip 2 characters	2	
132	Skip 3 characters	3	
133	Skip 4 characters	4	
134	Skip 5 characters	5	
139	Ignore all characters to end of string	n	

Field Width Formatting Tokens		Uses	Formatting
160	Set the field width to 1 character	0	
161	Set the field width to 2 characters	0	
162	Set the field width to 3 characters	0	
163	Set the field width to 4 characters	0	
164	Set the field width to 5 characters	0	
165	Set the field width to 6 characters	0	
166	Set the field width to 7 characters	0	
167	Set the field width to 8 characters	0	Default
168	Set the field width to 9 characters	0	
169	Set the field width to any number of characters (max 9)	0	

Decimal Point Formatting Tokens		Uses	Formatting
150	No decimal point expected	0	
151	Expect decimal point sent as full stop ('.')	0	Default
152	Expect decimal point sent as comma (',')	0	

Field Type Formatting Tokens		Uses	Formatting
140	Expect the field as weight only	0	
141	Expect the field as either weight or text	0	Default
142	Expect the field as text only	0	
143	Specify the field as Net weight	0	
144	Specify the field as Gross weight	0	

Field Parsing Tokens		Uses	Parsing
170	Parse string for field to store as field 1	See Width Tokens	
171	Parse string for field to store as field 2		
172	Parse string for field to store as field 3		
173	Parse string for field to store as field 4		
174	Parse string for field to store as field 5		

Standard Status Parsing Tokens		Uses	Parsing
180	Standard Ranger status	1	G,N,E,O,U,M
181	Ranger status without motion	1	G,N,E,O,U
182	Gross, Net only	1	G,N
183	Motion or stable	1	M,S
184	Motion or ' ' for stable	1	M,' '
185	Motion, over-capacity or valid weight	1	M,C,' '
186	Motion, invalid, over-capacity, or valid weight	1	M,I,O,' '
187	Inscale, overload, underload	1	I,O,U
188	Centre of Zero	1	Z,' '
189	Motion or any other character for stable	1	M
190	Lower case Motion, over-capacity or valid weight	1	m, c, ' '
191	Lower case gross/net	1	g, n

Additional Status Parsing Tokens		Uses	Parsing
200	Philips Status	2	Byte1, Bit3 = Overload Byte2, Bits01 = DP Posn
201	All field error status sets Error/Over/Under for all fields.	1	E, O, U
202	Toledo Status	3	Byte 1 Bit0 = Sign, Bit1 = Error Byte 2 Bits012 = DP Posn
204	Avery L130 Status 1	1	Bit0 = Error
205	Avery L130 Status 2	1	Bit0 = COZ, Bit1 = Gross, Bit2 = Net
206	Stable, unstable, overload	2	ST,US,OL
Display Tokens			Display
154	Show the decimal point on the display	0	
155	Hide the decimal point	0	
Field Delimiter Formatting Tokens		Uses	Formatting
240	Field delimiter is a comma (',')	0	
241	Field delimiter is a semicolon (';')	0	
242	Field delimiter is a single quote ('')	0	
243	Field delimiter is a double quote ('"')	0	
244	No field delimiter	0	Default
245	Field delimiter is ASCII 02 (STX)	0	
246	Field delimiter is ASCII 03 (ETX)	0	
Address and Active Field Parsing Tokens			Parsing
230	Expect a address field and match to unit address	2	
231	Expect a number to set the active field (0..4)	1	
232	Expect a G/T/N to set field 1/2/3 active, respectively	1	
Additional Parsing Tokens			Parsing
203	Expect number for decimal point position	1	(0..6)
249	Parse and ignore all characters until delimiter is found	n	

6. Configuring for Network Mode

Operating in Network Mode the **6700** may be connected to a slave **5000** or **5100** operating in network mode. In this mode, the **6700** queries the indicator for weight readings and status. The front panel keys on the **6700** are sent to the remote unit. Note that this mode requires a software license and may not be enabled on all units. Refer to Section 11.4 for details on software options.

6.1. Wiring Diagram for Network Mode

RS232 Connections

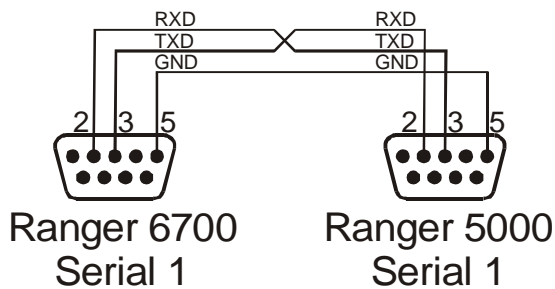

RS422/485 Connections

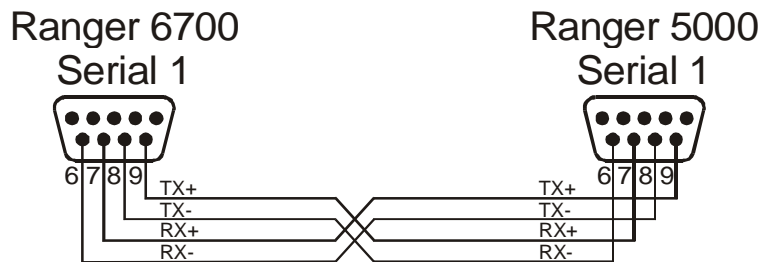

6.2. Configuring the Slave 5000 or 5100

For network operation the slave **5000** must be setup so that Serial Port 1 is operating as a network port (select 'net' from the SERIAL:SER1 item). Either RS232 or RS422/RS485 may be used. However it is advisable to use RS422/RS485 if the **6700** and the **5000** are installed more than 10 m apart.

6.3. Configuring the 6700 for Network Mode

- Enter the Operating Mode Setup menus (Press the Setup Key);
- Choose the type as Network Master (NET.M);
- Data Source (SERIAL:SRC) defaults to RS232, set if different;
- Baud Rate (SERIAL:BAUD) defaults to 9600, set if different;
- Serial Format (SERIAL:BITS) default to n81, set if different;

7. Configuring for Summing Mode

In Summing Mode the **6700** acts as the master controller for a number of slave **5000 / 5100** units connected together on a multi-drop serial RS422/RS485 bus. The **6700** polls each of the slave units and sums all of the weight readings. The resulting total weight is displayed on the **6700**.

Thus the **6700** will show an error message (E-----) if any of the slave weights are negative or if there is a mix of gross and net weights amongst the slave units. If all slave units are showing net weight the **6700** will show a net total.

This allows multiple **5000 / 5100** units to be installed to measure individual weight readings from numerous loadcells connected to the same scale base, with the **6700** displaying the total weight. In this way it is possible to determine the weight distribution of the load as well as the overall total weight.

Note that this mode requires a software license and may not be enabled on all units. Refer to Section 11.4 for details on software options.

7.1. Wiring Diagram for Summing Mode

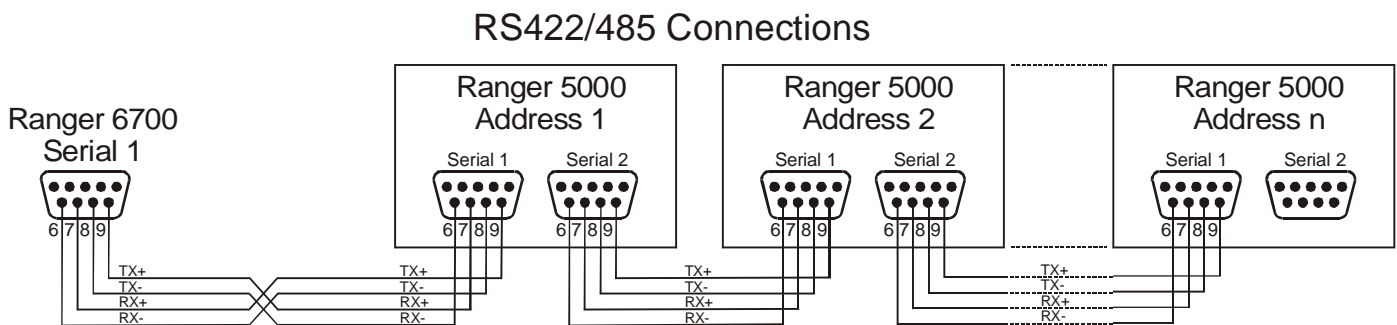

7.2. Configuring the Slave 5000s or 5100s

The slave 5000 units must be setup in network mode (set SERIAL:SER1 to net) and the communications must be done using RS422/RS485. Slave units are addressed starting at 1 up to the number of units in the network. This can be setup from the SERIAL:NET.OPT:ADDRes. Usually an installation will only use 2 or 4 slave units but the 6700 can support up to 10. Ensure that RS422 is enabled via the SERIAL:BITS menu item.

7.3. Configuring the 6700

- Enter the Operating Mode Setup menus (Press the Setup Key);
- Choose the type as Summing Master (SUM.M);
- Set the number of slave units (OPTION:SLAVES);
- Set the weight units to be displayed (OPTION:UNITS);
- Data Source (SERIAL:SRC) defaults to RS422;
- Baud Rate (SERIAL:BAUD) defaults to 9600, set if different;
- Serial Format (SERIAL:BITS) default to n81, set if different;

8. GENERAL SETUP

Setup of the **6700** is divided into two sections. The first section covers setup of the **6700** operating mode, and has been discussed previously in Section 4. The second section known as "GENERAL" setup, covers the setup of other features, not directly associated with a particular operating mode, and is covered below.

8.1. Passcodes

The **6700** uses a passcode to provide a security lock on all setup menus. Passcodes can be set from the General Setup menu item (OPTION:PASSCD). A setting of "000000" clears the passcode and allows free access to Digital Setup. This is the default setting and must be changed by the installer to restrict operator access. Any other number will enable the passcode function and restrict access to the setup menus. When a passcode is enabled, the **6700** will prompt for passcode confirmation before entering setup. A value of 000000 will be displayed, and the correct passcode must be entered, in the standard numeric entry fashion. Correct entry of the code will allow access to Setup, whilst an incorrect passcode will trigger an error message and the display will return to the normal weight display. **The passcode must not be forgotten, as it is only possible to circumvent it at the factory. Care must be taken with the use of the passcode to ensure that the instrument does not become permanently locked.**



8.2. Entering General Setup

SETUP
 To enter General Setup, remove the security screw, press and hold the button behind it for two seconds. The **6700** will display "GENRL SETUP 6700", followed by the software version. If a passcode has been configured, it must be entered to gain access to setup. The **6700** will then enter the General Setup menus.

8.3. Display Options - (OPTION)

Items within this Group are used to configure the **6700** display and control access to menus, button locking and external key functions



(SHowDP) Show the Decimal Point

Selects whether the decimal point is shown on the display. This setting provides the default which can be overridden in the format string.

Options: Yes, No. Default: Yes.

(TImEO) Data Time Out

Sets the period of time the unit waits from the last valid message, before displaying an error message.

Options: NoTimeout, 5, 10, 20. Default: 5.



(UNITS) Display Units

Selects the units to be displayed.

Options: g (grams), kg (kilograms), lb (pounds), t (tonnes). Default kg.



(PASS.Cd) Security Passcode for Setup Menus

This number must be entered as a passcode to access the Setup menus. A setting of 000000 bypasses the passcode function and allows free access.



Can be set from 000000 to 999999. Default: 000000.



(OPEr.PC) Security Passcode for Operator Menus

This number must be entered as a passcode to access the operator menus. A setting of 000000 bypasses the passcode function and allows free access.

Can be set from 000000 to 999999. Default: 000000.

(bUtton) Lock/Unlock Front Panel Operating Buttons

Set locking for buttons ZERO, TARE, GROSS/NET, and PRINT. Options are "y" to enable this button, "n" to disable this and "I" for immediate operation (don't wait for no motion for this button).

Default: y y y y (All enabled).

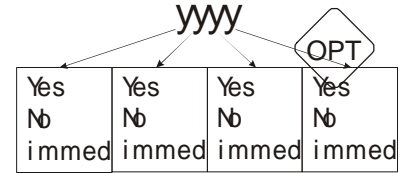

(InP.Fn) Function of External Inputs

Sets the function of each of the 4 remote inputs provided with the setpoint option card. See Section 12 (Page 51) for a detailed description of each of these functions.

Default: 0TGP

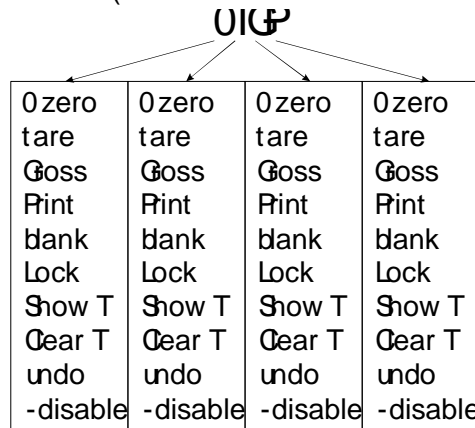

8.4. Serial Ports 2 and 3 Settings (SERIAL)

Items within this group are used to configure the second and third serial ports of the 6700 remote display.

(SER 2) Serial Port 2 Settings

Items within this sub-group configure serial port 2.

(TYPE2) Serial Port 2 Function



Refer to Section 9 for the operating modes of this port. Options for this port are:

- Off: Disable this port
- Net.S: Operate as a Network Slave
- AUTO: Generate an auto output on this port
- Print: Drive a printer from this port

Default: Net.S.

(SRC2) Data Source



The 6700 can accept data on serial port 2 in the following formats: RS232 and RS422. This option selects the data source.

Options: RS232, RS422. Default: RS232.

(BAUD2) Baud Rate



The baud rate item determines the serial data transmission/reception speed for the primary serial port.

Options: 300, 600, 1200, 2400, 4800, 9600, 19200. Default: 9600.

(Bits2) Serial Format Options



The bits options allow the data transmission bit pattern to be changed. The display will show the current setting in the form (n81Td) where each character has a meaning as shown below. Available options are:

- n,O,E: Parity bit
- 8, 7: The number of data bits
- 1, 2: The number of stop bits
- , T: Termination resistors
- , d: Monitor DTR line

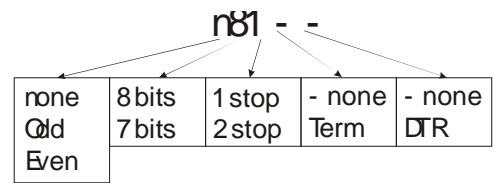

Default: n81--. For most applications the default setting is applicable.

(ADDR2) Serial Address



Sets the serial address for the secondary serial port.

Can be set from 00 to 99.

(SER 3) Serial Port 3 Settings

Items within this sub-group configure serial port 3. Note that Serial Port 3 operates at the same baud rate and bits setting as Serial Port 1.

(TYPE3) Serial Port 3 Function



Refer to Section 9 for the operating modes of this port. Options for this port are:

- Off: Disable this port
- AUTO: Generate an auto output on this port
- Print: Drive a printer from this port

Default: AUTO.

(Bits3) Serial Options



The bits options allow the control of the port. Note that the baud rate and bit pattern are tied to Serial Port 1. The display will show the current setting in the form (Td) where each character has a meaning as shown below. Available options are:

- , T: Termination resistors
- , d: Monitor DTR line

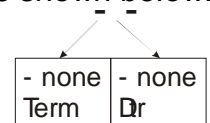

Default: - .

(Aut.OPt) Auto Transmit Options

This is a list of all items concerned with automatic serial transmission of weight data.

(AUTO.TP) Auto Output Format 

This item sets the type of Auto transmit data format. Description of these formats is given in Section 9.1 on Page 36.

Options are: Auto.A (Std Ranger), Auto.B, Auto.C, Auto.D, Auto.E, Custom (Format specified in AUT.FMT). Default: Auto.A.

(Src) Auto Output Source 

Selects the weight source for the output data.

Options are DISP (Displayed weight), GroSS (Gross weight), Net (Net weight), Total (Total weight). Default: DISP.

(Aut.Fmt) Auto Output Format 

Sets the auto output format when using Custom formatting. Up to 20 literal characters and special tokens can be entered.

Default: "" (No format specified).

(St.Chr) Start Character 

Sets the character sent at the start of the automatic message string. Can be set for any valid ASCII character. If set to Null (00), no character will be sent in this position.

Default: 02 (Start Of Text (STX))

(End.ch1) End Character 1 

Sets the first of the two characters sent at the end of the automatic message string. Can be set for any valid ASCII character. If set to Null (00), no character will be sent in this position.

Default: 03 (End Of Text (ETX))

(End.ch2) End Character 2 

Sets the second of the two characters sent at the end of the automatic message string. Can be set for any valid ASCII character. If set to Null (00), no character will be sent in this position.

Default: 00 (no character sent)

(Prn.OPt) Printing Options

This is a list of all items concerned with printing.

(Prnt.TP) Printer Output Type 

This item sets the type of printout sent via the serial port when the **PRINT** button is pressed. Descriptions of these printouts are given in Section 9, Page 36.

Options are SING/A.SING (Print/Auto print a single line), Doub/A.doub (Print/Auto print single line double spaced), Tic/A.tic (Print/Auto print full

weight ticket), *TotAl* (*Totalising printer mode*), *A.totAl* (*Automatic totalising*).
Default: SING.

(HDR 1) Ticket Header Line 1



The custom ticket header can be entered here. Refer to Section 9.4.3 (page 42) for information on the method of entering a custom header.

(HDR 2) Ticket Header Line 2



The custom ticket header can be entered here. Refer to Section 9.4.3 (page 42) for information on the method of entering a custom header.

(Tic.Fmt) Ticket Format



A custom ticket format can be entered here. Refer to Section 9.4.4 (page 42) for information on custom ticket format entry.

(SPC.col) Margin Space (Columns)



The number of columns of space to leave for each printout can be entered here.

Can be set from 0 to 20. Default: 0.

(SPC.ROW) Margin Space (Rows)



The number of rows of space to leave for each printout can be entered here.

Can be set from 0 to 10. Default: 0.

8.5. Test Menu - (TEST)

Items within this group allow testing of display features, and provide feedback on display conditions.

(tEST.IO) Test Digital Inputs and Outputs

Items within this sub-group allow testing of the optional accessory cards.

(Frc.Out) Force Outputs of the Setpoint Card

Forces each of the output drivers of the Setpoint card in turn. All outputs turn OFF when leaving this step.

(tSt.InP) Test the Inputs of the Setpoint Card

All four inputs are displayed at the same time. The status of the inputs is changed as contact closures are detected. The symbol "-" indicates an input not present, whilst (1/2/3/4) indicate a contact closure detected on input 1/2/3/4, respectively.

(AUTO) Serial Auto Settings

This option displays the current serial auto settings for the primary serial port. It displays source, baud rate and serial bit format, when auto settings are enabled. This option is not available when automatic detection is disabled.

(SCAN)Serial Data Scan

This option forces the remote display to perform a scan and autobaud of the primary serial port if the auto options are enabled. Note that the display performs a scan on powerup and on exiting the setup menus. This option is not available when automatic detection is disabled.

(STAT) Remote Display Status

This option provides information to the user when configuring the unit. The data displayed here applies to the Primary serial port only. A description of each item is given below. Pressing a key advances to the next item.

- RxCnt - This displays the number of bytes the unit has received on the Primary serial port. If this number is not increasing, check the following items:
 - The data source is correct (DATA:SRC);
 - The data cable is wired correctly and in the correct port;
 - The indicator is sending data;
 - The baud rate and serial format is correct;
- RxErr - This displays the number of receive errors that have occurred. If this number is increasing, check the following items:
 - The baud rate and serial format are correct;
 - Intermittent connections on the data cable;
- RFAIL - This displays the position in the format string at which the last message interpretation failed. A reading of zero indicates that the message was parsed correctly.

(DISPLY) Display Test

This option forces the remote display to perform a display test. The test runs indefinitely, until a key is pressed.

(TMINAL) Remote Display Terminal

This menu captures data from the primary port when operating Remote Display mode and displays it in an unformatted state. Use the Group key to scroll left, the Item key to scroll right. A long press of the Item key will switch between views. Pressing the Edit key will exit the menu.

(CFGFMT) Configure Format from Datastream

This option creates a Remote Display format string from the incoming data stream. It prompts for which format to overwrite (1-4), then acquires data from the primary port. It then requests the ETX character be selected, followed by the field start position and the field end position. From this information the format string is created.

8.6. Set Points - (SEt.PtS)

Items within this group set the operational logic of the setpoint system, as well as setpoint target and flight values. Set the 'Active' status of each of the 4 setpoints first. All other menus are based on this initial setup so that unused settings and unavailable combinations are removed. Refer to Section 10 (Page 44) for specific examples.

(ActiveE) Enable Setpoints

Sets the role of each of the four setpoints. See Section 10.4.1 (Page 44) for details on all the active modes for the setpoints.

Default: - - - - (All disabled).

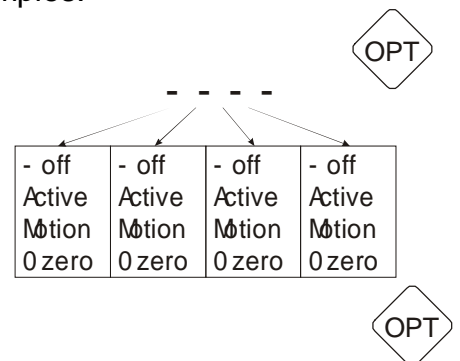

(LOC) Lock Out Operator Changes to Setpoints

Allows/prevents operator access to each setpoint via the TARE key. A setpoint can be *locked* (L) or left *unlocked* (-).

Default: - - - - (All unlocked).

(SrC) Weight Data Source



Each setpoint can be set to work from either the *Gross Weight* (G) or the *Net Weight* (n).

Default: G G G G (All gross).

(dir) Output Switching Direction



Sets the direction of action of the outputs. Can be set to either *Over* (O) or *Under* (U).

Default: O O O O (All over).

(LOGIC) Active Relay Logic



Determines the sense of the outputs. Options are: *Active high* (H) or *Active low* (L).

Default: H H H H (All active high).

(Alarm) Setpoint Alarms



Sets the alarm options for each setpoint. Alarms can be *off* (-), *single beep* (S), *double beep* (d) or *continuous* (C).

(Target) Target Settings



This lists target values for the active setpoints. **Targ 1** to **Targ 4** menu options are visible depending on which setpoints are active. Each of these is the primary weight target for the particular setpoint.

Can be set from -99999 to 999999. Default: 0.

(HYS) Hysteresis/Tolerance Settings



This lists hysteresis values for the active setpoints. **HYS1** to **HYS 4** menu options are visible depending on which setpoints are active. Hysteresis values are also used to specify the weight tolerance for batching. A value of 0 disables tolerance checking.

Can be set from 0 to 999999. Default: 0.

(FLt) In-flight Settings



This lists In-Flight values for the active setpoints. **FLt 1** to **FLt 4** menu options are visible depending on which setpoints are active.

Can be set from 0 to 999999. Default: 0.

(FLt.Ad) Automatic In-flight Adjustment



In-flight settings can be automatically adjusted to remove batching errors. The inflight adjustment sets the percentage of a batch error that is used to correct the inflight value. Note that an inflight setting can not be adjusted by more than 50% of its current value regardless of the batching error.

Can be set from 0% to 50%. Default: 0%.

8.7. Analogue Settings - (AnALoG)

Items within this group set the options for the optional combination output card.

(SRC) Set the Analog Reading Source



Select the reading source for analogue transmission. Available options:

Options: *DISP* (displayed weight), *GROSS* (Gross weight), *Net* (Net weight).
Default: *DISP*.

(TYPE) Set the Analog Output Type



Select the type of analog output. Voltage output is -10V to 0 to 10V with 0V at 0 weight. The current output is 4-20 mA, whilst absolute current is 4-20 mA current based on absolute weight, where negative weight readings are transmitted with positive current.

Options: *VOLT* (Voltage), *Cur* (Current), *Abs.Cur* (Absolute current). Default: *Cur*.

(CAL.Lo) Calibrate the Zero Output

This item allows fine calibration of the analogue output corresponding to zero weight (Current: 4mA or voltage: 0V). See Section 11.3.1 on page 49 for details on how to use the ANALOG:CAL.Lo item.

(CAL.Hi) Calibrate the Fullscale Output

This allows a fine calibration of the analogue output corresponding to fullscale weight (Current: 20mA or voltage: 10 V). See Section 11.3.1 on page 49 for details on how to use the ANALOG:CAL.Hi item.

(Frc.AnI) Test Analogue Output

Test analogue output. This function forces the analogue output either Low (0V/4mA) or High (10V/20mA) so that the analogue output function can be tested independent of the weight readings.

8.8. Clock Settings (CLOC)

Items within this group set the clock/calendar.

(TIME) Set Current Time



The correct time is entered here in the format HH.MM, where HH is the hours in 24 hour format (00 – 23), and MM is the minutes (00 – 59).

(TIME) Set Current Date



The current date is entered here in European format (DD.MM.YYYY). DD.MM is entered first followed by YYYY, where DD is the day of the month (01 - 31), MM is the month of year (01 - 12), and YYYY - year (1998 - 2098).

8.9. Factory Adjustment Menu - (FACtry)

(deflt) Restore Factory Defaults



Restores the digital setup of the 6700 back to the original “new” settings

installed at the factory. The **6700** prompts to continue before restoring the default settings.

(fac.rst) Factory Reset

Factory access only.

(config) Software Options



Use this item to enter software option codes to enable optional features in the **6700**. Refer to Section 11.4.

8.10. Leaving General Setup Menus - (-END-)

To exit setup and return to normal operation, press the **GROUP** key until the **-END-** group header appears in the display. Then press the **ITEM** button to exit the setup. The **6700** will display "Saving" before returning to normal operation.

9. The Serial Outputs

The **6700** provides a two of serial output options allowing communications with external devices such as printers, computers, PLCs or other remote displays. Serial port 1 is used exclusively as an input port for receiving data from indicators.

Two serial output ports are available, each on a separate DB9 connector socket. Serial Port 2 is bi-directional (in either RS232 or RS422/485 formats), and is used to connect the **6700** to an accessory, such as a PC, printer or Remote Display. Serial Port 3 provides RS232 and RS422 as transmit only, and can be set for Automatic Output or Printing (with DTR handshake). Note that the baud rate and bit pattern of Serial Port 3 is tied to that of Serial Port 1.

The various printer and serial output options are enabled using the Serial menu (Serial) in General setup. The bit pattern of the serial data can be altered, as can the start and end characters of the automatic data strings.

Printer driving allows for three basic printer outputs including a date and time stamped printed ticket with a custom header if required. An automatic print mode is available where the **6700** automatically generates printouts at the appropriate time in the weighing process.

9.1. Serial Ports 2 and 3

All connections for this port are on the Serial 2 connector. This is a standard DB9 socket requiring a female DB9 plug. The output available from Serial 2 is RS232 & RS422. The connections for this are shown below.

9.1.1. Connections

Pin No.	Function	Description	Connect To
3	TX2	Output Transmit Line	External Device Receiver (Usually Pin 3 of DB25)
5	GND2	Digital Ground	External Device Digital Ground (Usually Pin 7 of DB25)
4	DTR	DTR Handshake Line	External Device Busy Line (Usually Pin 20 of DB25)

Connect shield directly to the metal DB9 back shell.

9.1.2. Transmission Control for Printing

Serial Ports 2 and 3 support the DTR handshake line. This enables a printer to signal the **6700** when paper has run out or is off-line. Monitoring of this line can be enabled or disabled via the SERIAL:SER2:BITS and SERIAL:SER3:BITS of General setup for Serial Ports 2 and 3 respectively.

9.1.3. RS422/485 Termination Resistors

The termination resistors required by RS422/RS485 networks are built into the **6700** on all ports. The resistors are used to terminate the ends of the network to provide a balanced loading. The termination resistors in the **6700** are enabled the SERIAL:BITS of Operating Mode Setup for Serial Port 1 and SERIAL:SER2:BITS and SERIAL:SER3:BITS of General setup for Serial Ports 2 and 3 respectively.

9.2. Network Slave Mode

Network Slave mode is required to utilise the Windows viewer software or for serial summing of multiple 6700s.

Network Slave mode is a bi-directional protocol, in which the instrument receives commands and replies with data or acknowledgment. It is only available on Serial Port 2 of the 6700 as the third port is restricted transmit only.

The standard 6700 protocol supports a basic and extended level of slave networking. The basic level allows for remote operation of the keys by a PLC or on a RS232 or RS422 network. The extended network language allows for full control over all functions of the instrument. For details of the command structure and actual commands, refer to the 6700 Communications Manual.

9.2.1. Wiring Diagrams for Network Slave Mode

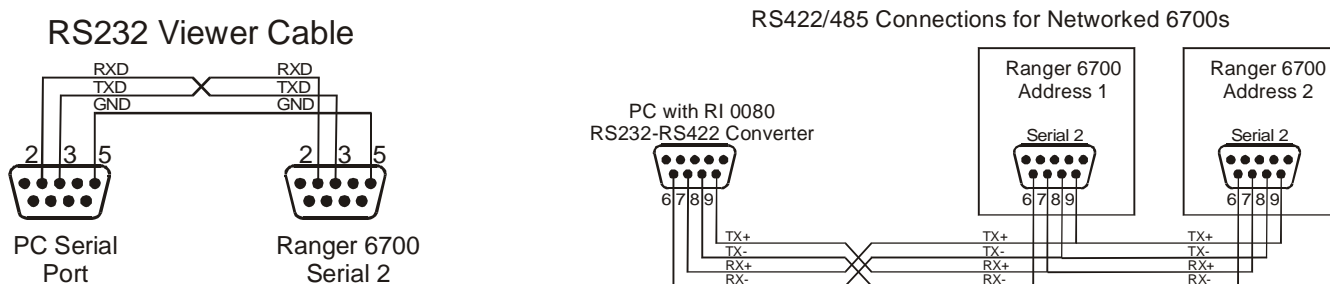

9.2.2. Configuring the 6700 for Network Slave

- Enter the General Setup menus (Press the Setup Key for 2 seconds);
- Set the type (SERIAL:SER2:TYPE) to NET.S;
- Set the data source (SERIAL:SER2:SRC);
- Set the baud rate (SERIAL:SER2:BAUD);
- Set the serial format (SERIAL:SER2:BITS);
- Set the address (SERIAL:SER2:ADDR).

9.3. Automatic Weight Output from the 6700

The automatic output is normally used to drive remote displays, a dedicated computer or PLC communications. The output generates a simple weight message ten times per second.

The 6700 Auto Weight String consists of four basic Weight Formats bounded by three Programmable Characters. The weight format and Programmable Characters can be defined in the setup. If a Programmable Character is set to NULL (ASCII 00) then it will not be transmitted. The standard string is as follows:

START - <Weight Format String> - END1 - END2

Where:

START is the character (SERIAL:AUT.OPT:ST.CHR). *Default: ASCII 02.*

END1 is the 1st end character (SERIAL:AUT.OPT:END.CH1). *Default: ASCII 03.*

END2 is the 2nd end character (SERIAL:AUT.OPT:END.CH2). *Default: ASCII 00.*

Note: START, END1 or END2 characters which have been set to NULL (ASCII 00) are not transmitted. Another common alternative configuration is START = NULL, END1 = CR (ASCII 13), END2 = LF (ASCII 10).

9.3.1. Auto Weight Formats A to E and Custom

The five standard weight formats are detailed below. These are selected from the SERIAL:AUT.OPT:Auto.TP setting of the General Menus. Spaces (ASCII 32) are indicated by a □.

Format	Description
A	Sign WeightA(7) Status
B	Status Sign WeightA(7) Units(3)
C	Sign WeightA(7) S1 S2 S3 S4 Units(3)
D	Sign WeightA(7)
E	Sign WeightB(7) S5 Units(3) Mode(4)
F	Programmable weight format

Where

Sign	is the sign of the weight reading (space for positive, '-' for negative);
WeightA	is a seven character string containing the current weight including the decimal point. If there is no decimal point, then the first character is a space. Leading zero blanking applies.
WeightB	is a seven character string containing the current weight including the decimal point. If no decimal point is used a decimal point follows the 6 digits of weight data. Leading zeros are shown;
Status	provides information on the weight reading. The characters G/N/U/O/M/E represent Gross/Net/Underload/Overload/ Motion/Error, respectively.
Units	is a three character string, the first character being a space, followed by the actual units (E.g. " □kg" or " □ □ t"). If the weight reading is not stable, the units string is sent as " □ □ □ ".
S1	displays G/N/U/O/E representing Gross/Net/Underload/Overload/ Error, respectively;
S2	displays "M"/' ' representing motion/stable, respectively;
S3	displays "Z"/' ' representing center of zero/non-zero, respectively;
S4	displays "1"/"2"/"-" representing range 1/2 in dual-interval and dual range mode and "-" otherwise;
S5	displays "□"/"m"/"c" representing stable/motion/over or under capacity, respectively;
Mode	4 characters ' □ g □ □ ' or ' □ n □ □ ' for gross or net weight.

9.3.2. Auto Transmit Formatting

The Auto Format (SERIAL:AUT.OPT:AUT.FMT) setting of General setup programs the format transmitted when the Auto Format Type (SERIAL:AUT.OPT:AUTO.TP) is set to "Custom". A string of up to 20 characters can be entered. Each ASCII character is either a literal ASCII printed character like 065 ('A') or a special token character like 202 (123.4) which sends the gross weight. The ASCII 0 is used to mark the end of the format string. To send an ASCII 0, insert an ASCII 128.

Qualifiers are tokens that do not cause any characters to be transmitted but modify the format of other tokens to follow.

For example, the following format string would transmit the weight reading in a fixed 7 character field with leading zero suppression and no decimal point:

9.3.3. Programmable Auto Transmit Tokens

Following is a table of all of the format tokens.

ASCII	Token	Comment
Qualifier Tokens		
170	5 character field	
171	6 character field	
172	7 character field	
173	8 character field	Default
174	9 character field	
179	No fixed length field for weight data	
180	No sign character sent	
181	Sign character send as '+' for positive and '-' for negative	Default
182	Sign character send as '+' for positive and '-' for negative	
183	Sign character send as '0' for positive and '-' for negative	
184	No decimal point sent	
185	DP sent as '.'	Default
186	DP sent as ','	
187	Weight sent with leading zeros, eg 000123	
188	Weight sent without leading zeros eg 123	Default
189	Weight readings sent regardless of overload or error status	Default
190	Weight data blanked on error	
191	Weight data send as '---' on error	
192	Status characters are upper case	Default
193	Status characters are lower case	

Tokens for Weight Data Transmission		
200	Selected Weight (SRC)	
201	Displayed Weight	
202	Gross Weight	
203	Net Weight	
204	Tare Weight	
205	Total	
206	Displayed String including user prompts etc.	

Following are Tokens for Weight Status		
210	Units	'kg', 'lb', 't', 'g'
211	G,N,E,O,U,M	Standard Ranger status
212	G,N,E,O,U	Ranger status without motion
213	G,N	Gross, Net only
214	M, ' '	Motion or ' ' for stable
215	M,S	Motion or stable
216	' ', or units	' ' for motion or weight units
217	M,C, ' '	Motion, over-capacity or valid weight
218	M,I,O, ' '	Motion, invalid, over-capacity, or valid weight
219	I,O,U	Inscale, overload, underload
220	Z, ' '	Centre of Zero
221	' ', 1,2	Single range or range/interval 1or2
222	ST,US,OL	Stable, unstable, overload

230	Send time	Hh:mm:ss
231	Send Date	Dd/mm/yyyy

9.3.4. ASCII Codes for Tickets Formats

Refer to Section 15 on Page 55 for a list of all ASCII Codes.

9.4. Printer Driving

The 6700 supports a range of printing facilities, including:

- Manual Printing
- Automatic Printing
- Manual/Automatic Totalising and Printing

9.4.1. Printer Output Formats

A range of printer formats can be selected from the SERIAL:PRN.OPT:PRNT.TP item of General setup. Below are descriptions of the four available formats.

9.4.1.1. The Single Line Printout (*SING* and *A.SING*)

A single line printout is intended to produce the most compact printout. The printout is shown in the example below:

000024	02/03/2000	16:27:31	150.0	kg	G
ID	Date	Time	Weight	Units	Status

Each item is described below:

- ID The ID is a 4 digit sequential counter that is incremented with every printout up to a maximum of 999999 before cycling back to 0. This counter is stored in battery backed memory. It is not directly available for the operator to change.
- Time/Date Current time and date
- Weight The displayed weight
- Units The weight units set in the scale build
- Status The type of weight reading (Gross/Net)

The auto single line printout option (A.SING) produces the same output as a single line printout, however the 6700 generates the output automatically.

9.4.1.2. Double Spaced Printout (*doub* and *A.DOUB*)

A double spaced printout contains the same information as the single line printout above, however the printout is spread over two lines.

Example:

000026	02/03/2000	16:31:31			
			150.0	kg	G

The auto double line printout option (A.DOUB) produces the same output as a double line printout, however the 6700 generates the output automatically.

9.4.1.3. Full Printed Ticket (*tic* and *A.TIC*)

The Full Printed Ticket produces a full ticket-style printout containing all the weight parameters and includes the date and time. Provision has been made for a user configurable two line header at the top of the ticket. Please refer to Section 9.4.3 (Page 42) for information regarding the header.

The ticket format can be modified via the ticket format menu (SERIAL:PRN.OPT:TIC.FMT) of General Setup. Refer to Section 9.4.4 (Page 42). The default printed ticket for remote display and 1-1 mimic modes is as shown below. This is the format used if there is no custom ticket format entered.

```

WEIGHT
TICKET
05/10/1999 16:50:12
ID: 000008
T:          654 kg
G:          3654 kg
N:          3000 kg

```

The full printed ticket for master operation is shown below for a system with 4 slave units.

```

WEIGHT
TICKET
05/10/94 16:50:12
ID: 0008
1: 102.5 kg G
2: 101.0 kg G
3: 155.7 kg G
4: 123.6 kg G
TOTAL: 482.8 kg G

```

The auto ticket printout option (A.TIC) produces the same output as a full printed ticket, however the 6700 generates the output automatically.

9.4.1.4. Total Ticket Printing (tTOTAL and A.TOTAL)

To enable totalising select "Total" or "A.Total" from the Printer Output Menu (see Section 8.4 on page 27). Select "Print" from the "SER2" menu if the weights and totals are to be physically printed out, otherwise they will only be displayed.

The operation of each press of the Print Key causes a single line printout of the current weight which is added to the total weight. When all of the items have been weighed press the Print Key for 2 seconds to print and clear the total. See Section 12.1.4 (Page 51) for extended totalising functions using external keys.

An example of a total printed ticket is shown below:

```

000491 01/01/1999 10:35:08 100.2 kg G
000492 01/01/1999 10:35:08 105.7 kg G
000493 01/01/1999 10:35:08 124.9 kg G
ITEMS: 3 TOTAL: 330.8 kg

```

The auto totalising option (A.TOTAL) produces the same output as totalising, however the 6700 generates the output automatically.

9.4.2. Printer Space

It is possible to specify the number of columns and rows of space to leave around each printout. This allows each printout to be separated from the next by a number of rows

of whitespace and the printouts may be centered on the page. The column and row space data is entered from the SERIAL:PRN.OPT:SPC.coL and SERIAL:PRN.OPT:SPC.row menu items respectively, of General Setup.

9.4.3. Custom Ticket Headers

The 2 lines of 20 characters at the top of the printed ticket can be edited to provide custom headers including such items as company names and phone numbers. These can be edited from the Header items (SERIAL:PRN.OPT:HDR 1 and SERIAL:PRN.OPT:HDR 2) of General setup.

Example: The following table shows the coded entry for “JOE’S FRUIT & VEG”. The ‘J’ would be entered as 1.08.074 for line 1, column 8, ASCII Code 74.

	01	02	03	04	05	06	07	08	09	10	11	12	13	14	15	16	17	18	19	20
1								J	O	E	'	S								
	32	32	32	32	32	32	32	74	79	69	39	83	32	32	32	32	32	32	32	32
2				F	R	U	I	T												
	32	32	32	70	82	85	73	84	32	38	32	86	69	71	32	32	32	32	32	32

9.4.4. Custom Ticket Format

Up to 50 characters of ticket format information can be entered to define the exact style of ticket printout. The ticket can be configured from the Ticket Format item (SERIAL:PRN.OPT:TIC.FMT) of General Setup.

Enter NULL (ASCII 00) as the last character in the string. Each format character can be a literal ASCII code (e.g. 065 for ‘A’) or a special format character (e.g. 132 for \D for a time/date field).

The following table shows the available format characters. These same format characters may be sent in a temporary weight string via the network communications to define the format of a single printout.

ASCII Code	Escape Sequence	Effect
128	\.	Print a literal NULL character (NULL can't be entered as 00 as this is used to identify the end of the format string)
129	\A	Print line 1 of custom header only. No CRLF is printed.
130	\B	Print line 2 of custom header only. No CRLF is printed.
131	\C	Print the number of Columns of SPACE specified by the Printer Space settings.
132	\D	Print Date Time field : hh:mm:ss dd:mm:yyy
133	\E	Print End of Line : literally prints CRLF (ASCII 013, 010)
135	\G	Print Gross Weight : “weight(7) units(3) G”
136	\H	Print Custom Ticket Header
137	\I	Print ID number
141	\M	Print all individual slave unit weights
141	\M\n	Print an individual slave weight, where N is slave address.
142	\N	Print Net Weight : “weight(7) units(3) N”
143	\O	Print Total Weight : “weight(7) units(3) G”
146	\R	Print the number of Rows of SPACE specified by the Printer Space

		settings.
148	\T	Print TARE weight: "weight(7) units(3) T (or PT if pre-set Tare active)
149	\U	Print units
151	\W	Print displayed weight. "weight(7) units(3) G (or N)
155	\+	Print displayed weight as with \W but add weight to total.
156	\-	Undo last \+ operation.

Example: The following table shows the coded entry for a custom ticket. The header is the same as the example custom ticket header entered above.

No.	01	02	03	04	05	06	07	08	09	10	11	12	13	14	15	16
Code	\H	I	D	:	\I	\E	\D	\E					\N	\E	\E	End
ASCII	136	073	068	058	137	133	132	133	32	32	32	32	128	133	133	00

The printout from this configuration is shown below:

```

      JOE'S
      FRUIT & VEG
      ID: 000005
      01/01/1999 10:25:30
      25.5 kg N
    
```

9.4.5. ASCII Codes for Tickets Formats

Refer to Section 15 on Page 55 for a list of all ASCII Codes.

9.4.6. Printer Control

Most printers use embedded control characters to specify different fonts, colors and paper cutting. Consult your printer manual for details of these control characters. Enter the control characters directly into the printer ticket format string to create the desired printing effects.

10. SETPOINTS

10.1. Introduction

The **6700** is fitted with four built-in setpoints. The status of the setpoints is displayed on four LEDs in the display window. An optional Setpoint card can be fitted to allow each of the setpoints to drive external devices. The LEDs then show the status of the output drivers.

Each of the setpoints provides a simple comparator function that can be modified in the digital setup for switching direction, hysteresis and logic. These settings are all that are required to configure normal level or limit operation. Free-Flight (Free-Fall) functions can be enabled to configure the **6700** for weight-batching applications.

Weight target and flight settings can be preset in the digital setup. This method is used where the settings are changed infrequently, and are to be as tamper-proof as possible. Optionally, weight target and flight settings can be set from the front panel buttons. This allows settings to be changed much more readily by the operator.

10.2. The Status LEDs

The display of the **6700** contains four status LEDs labeled 1, 2, 3 and 4. Each of these corresponds to a setpoint status, where the LED number represents the number of the setpoint displayed. Each LED is linked with the output driver in such a way that when the driver is ON (enabled) the LED is ON.

Note that for multi-range instruments the status LEDs are used to show the current range and not setpoint status.

10.3. Connection

Refer to Section 11: ACCESSORIES AND OPTIONS on page 47 for the method of connection of the external output drivers.

10.4. Settings

Setpoint targets and flights can be entered into the digital setup in the Setpoint Group (SET.PTS.) of General Setup. Any change to a setpoint value will be used immediately. An alternative method of accessing the setpoint values is via the front buttons. See Section 3.5 (Page 8) for details on operator access to setpoint parameters. The following sections describe each of the available setpoint settings.

10.4.1. Activity

Each of the setpoints may be disabled in the digital setup. Any setpoint set to be Active will be enabled. A motion setpoint indicates there is motion on the remote unit. A zero setpoint indicates a zero reading on the remote unit.

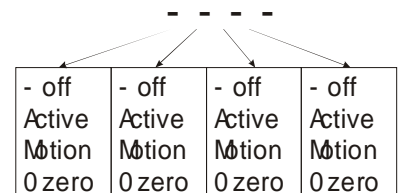

10.4.2. Locking

Individual setpoints can be locked against operator alteration. Setpoints that have been locked to block access via the TARE key may still be edited in the safe setup. If a particular setpoint is not enabled, a “-” is displayed, and no alteration can be made.

10.4.3.Source

The Source setting directs each setpoint to operate off either the Gross or Net weight reading. If a particular setpoint is not enabled, a “-“ is displayed, and no alteration can be made.

10.4.4.Direction

This determines the direction of weight movement that the setpoint is intended to trip on. It can be set for Over (for increasing weights) or Under (for decreasing weight). Use ‘Over’ in applications where the weight increases toward the target value, for example in the filling of a weigh bin. Use ‘Under’ in applications where the weight decreases towards the target or when using negative targets, for example when weighing out of a silo. If a particular setpoint is not enabled, a “-“ is displayed, and no alteration can be made.

10.4.5.Logic

Logic determines the sense of the output. Logic High is the normal operation of the output. Consider the example of an overload alarm where the output is ON for weights over the target value and OFF otherwise. This corresponds to Logic High operation. Logic Low reverses the operation of the output so it would be ON below the target and OFF above it. If a particular setpoint is not enabled, a “-“ is displayed, and no alteration can be made.

10.4.6.Alarm

The **6700** can be set to sound it’s internal beeper when any particular setpoint output is energized. Three types of warning sounds are available to allow the audible response to be designed to suit the weighing application. Audible alarms can be either continuous, sounding once, or sounding twice, at one second intervals.

10.4.7.Hysteresis

Hysteresis forces a preset margin in the trip point. This stops the output from ‘chattering’ due to minor weight fluctuations at the trip point value. For increasing weights (Over) the hysteresis is used below the trip point and for decreasing weights (Under) it is used above the trip point.

10.4.8.Targets

This is the target weight value. The **6700** calculates a trip point based on the values of target, flight and the direction of operation. For increasing weights (Over) the trip point is the target value minus the flight compensation. For decreasing weights (Under) the trip point is the target value plus the flight compensation.

10.4.9.Flights

Flight compensation is used in weigh-batching installations to force the feeders to shut off early to allow for the amount of material still in flight between the feeder gate and the surface of material already in the weigh-bin. If a setting of 000000 is entered for the flight, then compensation for that setpoint will be disabled. This value is set manually by the operator and is not automatically adjusted by the indicator itself.

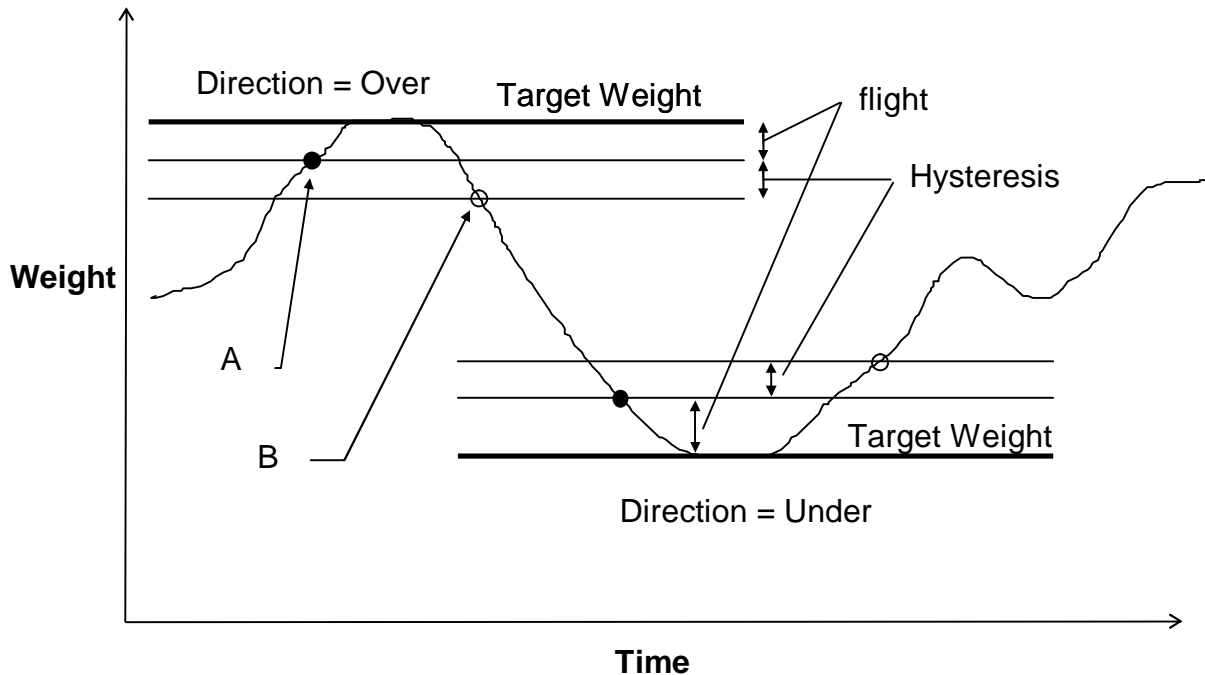

Operation of the Setpoints : Note the difference between Over and Under directions. If the Logic is set to 'High' the output is turned on at point 'A' and off again at point 'B'. If the Logic is set to 'Low' the output is turned off at point 'A' and on again at point 'B' .

Example 1: Level control of a 2000 kg tank with a shut off delay of 50 kg.

Direction = Over, Logic = Low, Source = Gross, Target = 2000kg, Flight = 50 kg, Hysteresis = 200 kg. Weight initially 0 kg.

Trip point = target - flight = 2000 - 50 = 1950 kg.

The output will initially switch ON at 0kg. The weight in the tank will increase to the trip point of 1950 kg and switch OFF. Due to the shut off delay the final weight in the tank will settle around the 2000 kg target. As product is removed from the tank the weight will drop until it falls below 1750 kg (trip point - hysteresis) at which time the output will turn ON again.

If the tank was gravity fed the logic could be changed to High and the output would then be initially OFF at 0 kg, switch ON at a weight over 1950 kg and switch OFF again as the weight fell below 1750 kg.

Example 2: Weighing product out of a silo into 100 kg drums.

Direction = Under, Logic = Low, Source = Net, Target = -100kg, Flight = 5 kg, Hysteresis = 1 kg. Weight initially 0 kg net.

Trip point = target + flight = -100 + 5 = -95 kg.

Once the TARE key is pressed the output will switch ON as 0 kg net is higher than the -95 kg net trip point. Product will leave the silo until the -95 kg trip point is reached and the output will switch OFF. The output will not switch on again until the net weight is higher than -94 kg (i.e. trip point + hysteresis).

11. ACCESSORIES AND OPTIONS

The **6700** can be expanded by the installation of optional accessory cards. Two different cards are available, a combination analog/digital output card and an output driver card with remote inputs.

11.1. Installing Option Cards

Isolate the 6700 from the power before attempting to install an accessory card. Avoid excess handling of the accessory card as each card contains static sensitive devices. Hold the card by the edges or mounting plate.

Each option card is installed into a slot in the back panel of the 6700. The slot is accessed by removing the cover plate at the top left. The connector lead is attached to the inside of this plate. Separate the lead from the plate taking care not to lose the lead inside the 6700. Discard the plate, but retain the two mounting screws. Clean any remnants of tape from the lead connector.

Plug the lead connector onto the four pin socket on the accessory card. The connector only fits one way round.

Slide the card into the slot in the back of the 6700, cable end first, until the mounting plate is fitted against the back plate. Re-install the two retaining screws.

VERY IMPORTANT

The EMC resistance of the accessory card depends on a sound electrical connection between the support plate and the case of the **6700**. Make sure that this connection is as sound as possible when refitting the two retaining screws.

11.2. The Setpoint Card

The standard 6700 displays the results of checkweigh or setpoint function on the front panel annunciator LEDs only. These signals can be used to drive external devices by installing an output driver card. The card carries four independent opto-isolated open-collector transistor drivers. These can be used to operate external devices such as relays, signal lamps or PLC inputs. The card also has four opto-isolated remote inputs that can be used to remotely trigger the four front panel buttons.

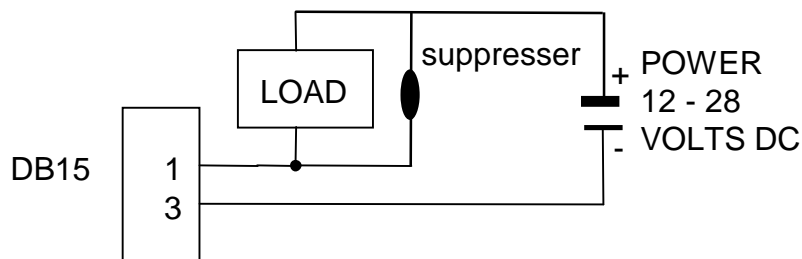

The output stage does not contain a power source and must be powered externally. The external supply should be from 12 to 28 volts DC and the maximum load current must be less than 0.5A.

The circuit diagram above shows a typical connection for one of the outputs. Each driver is protected against electrical noise, but it is strongly recommended that spark suppressors are fitted across any inductive loads such as relay and solenoid coils.

11.2.1. The Remote Inputs

Each input is opto-isolated, and requires a voltage input of between 5 and 28 volts DC to trigger. The following diagram shows a typical input circuit.

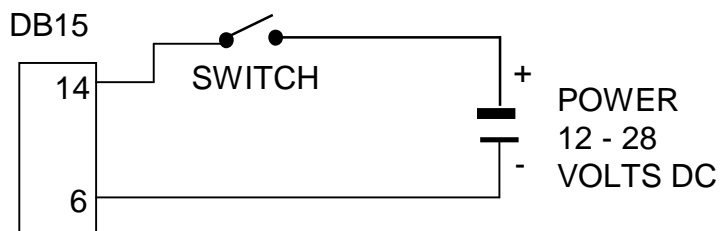

The following table shows the connections for the I/O card.

Pin No.	Function	Description	Connect To
1	OUT 1	Output 1	Load 1
9	OUT 2	Output 2	Load 2
2	OUT 3	Output 3	Load 3
10	OUT 4	Output 4	Load 4
3	OUTCOM	Output Common	Output Supply Negative
6	INCOM	Input Common	Input Supply Negative
14	IN 1	Remote Zero	Contacts 1
7	IN 2	Remote Tare	Contacts 2
15	IN 3	Remote Gross/Net	Contacts 3
8	IN 4	Remote Print	Contacts 4
SHELL	CH.GND	Chassis Ground	Cable Shield

11.3. The 'Combo' Card

This card provides either a -10 to 10 Volt or a 4 to 20 mA analogue output. In addition it also provides two outputs and one input as per the setpoint card. The outputs are isolated from the input and the analogue outputs. For more information on the connection of the outputs and input see details on the setpoint card above.

The current loop driver is active and supplies the source of power for the loop. The maximum circuit impedance must not exceed 500 ohms. The range of output is extended to include 0 .. 24mA which allows for readings outside 0 .. fullscale to be detected.

The Voltage output can drive into loads down to 2,000 ohms. The voltage output can be used with negative as well as positive weights with 0V representing zero weight and 10 V representing fullscale weight.

Shielded cable should be used for connecting the analogue outputs to external devices.

With the Combo-card either voltage or current output must be selected. It is not possible to drive both simultaneously. Fine adjustment of the analogue output is possible using the ANALOG:Cal.Lo and ANALOG:Cal.Hi options of General setup.

Note that the 6700 will only drive analog outputs in Network and Summing Master modes as the full-scale of the remote units is not available in the Remote display mode.

The following table shows the connections for the Multi card.

Pin No.	Function	Description	Connect To
1	OUT 1	Output 1	Load 1
9	OUT 2	Output 2	Load 2
3	OUTCOM	Output Common	Output Supply Negative
6	INCOM	Input Common	Input Supply Negative
14	IN 1	Remote Function 1	Contacts 1
4	V (+)	Voltage Output Positive	Minimum load 2000 ohms
5	I (+)	Current Loop Output	Maximum load 500 ohms
12	V(-)	Voltage Output Negative	
13	I (-)	Current Loop Return	
SHELL	CH.GND	Chassis Ground	Cable Shield

11.3.1. Fine Adjustment of Analogue Outputs

The analogue output from the combo card is factory calibrated, however in some applications it is necessary to fine tune the output to achieve maximum performance.

Calibrate the low output first followed by the high output. Use the ANALOG:FRC.ANL item of General setup to force the output Lo and Hi as a final check.

The fine adjustment procedure is carried out as follows:

- Use an external instrument to measure the analogue output.
- Select either ANALOG:CAL.Lo or ANALOG:CAL.Hi.
- Press the **SELECT** key to start the fine adjustment and switch between “**uP**” and “**dn**” to either increase or decrease the analogue output.
- Press the **CHANGE** key to make the adjustment. The analogue output is increased (“up”) or decreased (“dn”) every time the **CHANGE** key is pressed.
- For large changes hold the **CHANGE** key down and it will advance quickly;
- Press the **ITEM** key to save.

11.4. Licensing Options

Network Master and Summing Master modes are optional extras with the **6700**. The standard unit does not have these options enabled. To enable any of these options it is necessary to purchase a license code which may be entered into the instrument by the factory at the time of purchase or it may be entered via the setup menus at any time thereafter.

The license codes are unique to each instrument. To purchase a license code for an existing instrument the serial number (see sticker on rear of the instrument) must be obtained. Following is the procedure to enter a license code into the **6700**:

- Enter the General Setup Menu by holding the setup key for 2 seconds;
- Select the (**F**actory) group and the (**C**onFIG) item;
- Press **CHANGE** to enter the license code. The currently enabled licensing options will be displayed (n - Network Master, S - Summing Master);
- Enter the 6 digit License code and **ITEM** to accept the code;
- If the code is entered correctly, the updated licensing options are displayed. If not an error is displayed.
- Exit the setup menus.

12. Extended Functions

12.1. Introduction

The **6700** has up to four independent remote input functions that may be triggered by external keys connected to the optional setpoint card. The function of each of these keys may can be configured to any of the options detailed below. See Section 8.3 on page 26 for details on how to configure the remote input functions.

12.1.1. Front Panel Keys

The function of each of the front panel keys may be implemented with the remote keys. The Front Panel keys are designated '0TGP' to match Zero, Tare, Gross/Net and Print.

12.1.2. Blanking

This function designated 'b' for blanking allocates the selected input as a blanking input. When active this input causes the front display to be blanked to "-----" and blocks the operation of the front keys. This function is intended for use with tilt sensors on mobile weighing platforms to block operation of the weight indicator if the scale is not level.

12.1.3. Locking

This function designated 'L' for locking allocates the selected input as a locking input. When active all keys, including the remote keys are blocked. This may be used with a keylock switch to lock the instrument when not in use.

12.1.4. Totalising

Select the SERIAL:Prn.Opt:Prnt.tP item and set the printer output type to either Total or A.Total to enable totalising.

When Total Printing is enabled, the Print key is used not only to print the current weight but to add that weight to the current total. The **6700** displays "count" followed by the number of items in the total. After this "total" is displayed followed by the current total weight. If the total weight is too large to display in 6 digits, it is shown in two sections labeled as "TOT.HI" for the upper 6 digits and "TOT.LO" for the lower 6 digits. A long press of the Print key causes the total accumulated weight to be printed and then cleared.

Three other functions are available remotely. These are Show Current Total ('S'), Clear Total ('C') and undo last print ('u'). Show Current Total forces the indicator to display the number of items in the total followed by the current total weight. There is no printout. Clear Total prints the current total and clears it. Undo Last subtracts the last item added to the current total and prints "Last Entry Canceled".

See Section 9.4.1.4 on page 41 for details of the printed output from totalising.

13. SPECIFICATIONS

PERFORMANCE		
Display		6 digit green LEDs, 14.5mm high
Operating Environment		Temperature -10 to +50°C, humidity < 90% non condensing
DIGITAL		
Setup and calibration.		Full digital with visual prompting in plain messages
Memory retention		Full non volatile operation
SERIAL COMMS		
Serial outputs		Dual RS-232, plus RS-422/RS-485
Capabilities		Automatic transmit, network, or printer drive
Clock		Battery backed clock & calendar fitted
DIMENSIONS		
Case size		150mm wide x 72mm high x 100mm deep
Panel cutout		DIN 43 700 - 137(+1)mm wide x 68(+1)mm high
Power	DC	12/24VDC 10VA
	AC	86 - 260VAC 48 - 62 Hz 8VA
OPTIONS		
Combo option card		-10 to 10 V or 4-20mA opto isolated analogue output, two outputs and one input as per the Setpoint option card.
Setpoint option card		4 x isolated 50volt, 500mA open collector transistor drives and 4 x isolated digital inputs (5V to 28V).
No. of option slots		One
FEATURES		
		C-Tick approved
		Setpoint operation (requires setpoint accessory card)

14. ERROR MESSAGES

The **6700** operates a range of error detection mechanisms. These fall into three categories, which are described below.

14.1. Configuration Errors

Configuration errors provide feedback to the user of problems with the display setup. These errors are displayed by switching between the normal weight display and the error message. The priority of these errors decreases going down the table below.

Displayed Error	Description
ER.DAT	There is no data being received by the unit. Check cables, connections, indicator and data source configuration (SERIAL:SRC) from the Operating Mode menus.
ER.RCV	Data is being received, but the serial format is invalid. Check the baud rate, parity, stop and start bits (SERIAL:BAUD and SERIAL:BITS) from the Operating Mode menus.
ER.ETM	No character matching the specified ETX character has been found. Check the ETX character at the end of the format block (BLOCK:BLK1 .. BLOCK:BLK4) from the Operating Mode menus.
ER.FLD	An ETX character has been found, however some part of the data stream does not match the specified format. Check the format block (BLOCK:BLK1 .. BLOCK:BLK4) against the data being received in the Operating Mode menus
ER.LEN	The field to be displayed is longer than 6 digits and cannot be displayed. Check the data that is being sent to the display.

14.2. Weighing Errors

These messages show errors that have occurred during the normal weighing operation.

(U-----)	The weight is below the minimum allowable weight reading.
(O-----)	The weight is above the maximum allowable weight reading.
(-----)	The weight being transmitted is invalid (as per remote indicator).

14.3. Operating Errors

The **6700** continually monitors the condition of the internal circuits. Any faults or out-of-tolerance conditions are shown on the display as an E type error message. In the table below the following terms are used:

- (check) = this item can be checked on site by service personnel
- (service) = the **6700** must be returned for factory service

Code	Error Description	Action
(E 0001)	The power supply voltage is too low	(check supply)
(E 0002)	The power supply voltage is too high	(check supply)
(E 0100)	The user setup information has been lost	(re-enter user setup)
(E 0200)	The digital setup information has been lost	(re-enter setup)
(E 0300)	All setup information has been lost	(enter setup and calibrate)
(E 0400)	The factory information has been lost	(service)
(E 0800)	The EEPROM memory chip has failed	(service)
(E 8000)	The EPROM memory chip has failed	(service)

The "E" type error messages are additive. For example, if a condition is detected where the EEPROM memory chip has failed, resulting in a loss of setup information, the resulting Error messages will be E 0900 (0800 + 0100). The numbers add in hexadecimal as follows:-

1 - 2 - 3 - 4 - 5 - 6 - 7 - 8 - 9 - A - B - C - D - E - F (For example, 2 + 4 = 6, or 4 + 8 = C)



15. ASCII Codes

The following table shows the ASCII codes for control and printable characters.



Code	Char	Code	Char	Code	Char	Code	Char	Code	Char
000	NULL	026	SUB	052	'4'	078	'N'	104	'h'
001	SOH	027	ESC	053	'5'	079	'O'	105	'i'
002	STX	028	FS	054	'6'	080	'P'	106	'j'
003	ETX	029	GS	055	'7'	081	'Q'	107	'k'
004	EOT	030	RS	056	'8'	082	'R'	108	'l'
005	ENQ	031	US	057	'9'	083	'S'	109	'm'
006	ACK	032	' ' (space)	058	':'	084	'T'	110	'n'
007	BEL	033	'!	059	':'	085	'U'	111	'o'
008	BS	034	"""	060	'<'	086	'V'	112	'p'
009	HT	035	'#'	061	'='	087	'W'	113	'q'
010	LF	036	'\$'	062	'>'	088	'X'	114	'r'
011	VT	037	'%'	063	'?'	089	'Y'	115	's'
012	FF	038	'&'	064	'@'	090	'Z'	116	't'
013	CR	039	"""	065	'A'	091	'['	117	'u'
014	SO	040	'('	066	'B'	092	'\"	118	'v'
015	SI	041	')'	067	'C'	093	']'	119	'w'
016	DLE	042	'*'	068	'D'	094	'^'	120	'x'
017	DC1	043	'+'	069	'E'	095	'_'	121	'y'
018	DC2	044	','	070	'F'	096	``	122	'z'
019	DC3	045	':'	071	'G'	097	'a'	123	'{'
020	DC4	046	':'	072	'H'	098	'b'	124	' '
021	NAK	047	'/'	073	'I'	099	'c'	125	'}'
022	SYN	048	'0'	074	'J'	100	'd'	126	'~'
023	ETB	049	'1'	075	'K'	101	'e'	127	DEL
024	CAN	050	'2'	076	'L'	102	'f'		
025	EM	051	'3'	077	'M'	103	'g'		

16. SETUP MENU QUICK REFERENCE



6700 Remote Display Mode Menus

GROUP 	ITEM 	SELECT 	Description	Ref
Brand			Set brand of indicator for the remote display	4.3.1
SERIAL			Serial Port 1 options	4.3.2
	SRC		Data Source (RS232/RS422)	
	BAUD		Serial Baud Rate	
	BITS		Serial Bit Stream Configuration	
OPTION			Display Options	4.3.3
	TimeO		No Data Timeout Period	
	UNITS		Units to be displayed	
BLOCK			Data Format Block Section	4.3.4
	BLK1- BLK4		Data Format Blocks 1- 4	
	ENABLE		Enable/Disable Format Blocks	
	PRESET		Preconfigure a Data Format Block	
	RESET		Revert all Data Format Blocks to default	



6700 Network Master Mode Menus



GROUP 	ITEM 	SELECT 	Description	Ref
OPTION			Display Options	4.4.1
	TimeO		No Data Timeout Period	
SERIAL			Serial Port 1 Options	4.4.2
	SRC		Data Source (RS232/RS422)	
	BAUD		Serial Baud Rate	
	BITS		Serial Bit Stream Configuration	

6700 Summing Master Mode Menus

GROUP 	ITEM 	SELECT 	Description	Ref
OPTION			Display Options	4.5.1
	SLAVES		Number of slave units to sum	
	TimeO		No Data Timeout Period	
	UNITS		Units to be displayed	
SERIAL			Serial Port 1 options	4.5.2
	SRC		Data Source (RS232/RS422)	
	BAUD		Serial Baud Rate	
	BITS		Serial Bit Stream Configuration	

6700 General Menus

GROUP	ITEM	SELECT	Description	Ref
				
OPTION			General Display Options	8.3
	SHOWDP		Show/Hide decimal point	
	TimeO		No Data Timeout Period	
	UNITS		Units to be displayed	
	PASS.CD		Passcode to access setup menus	
	OPER.PC		Passcode to access operator menus	
	BUTTON		Lock/unlock buttons	
	INP.FN		Remote key function settings	
SERIAL			Serial Port 2 and 3 Options	8.4
	SER 2		Serial Port 2 Settings	
		TYPE2	Serial Port 2 Function	
		SRC2	Data Source (RS232/RS422)	
		BAUD2	Serial Port 2 Baud Rate	
		BITS2	Serial 2 Bit Stream Configuration	
		ADDR2	Serial Port 2 Address	
	SER 3		Serial Port 2 Settings	
		TYPE3	Serial Port 3 Function	
		BITS3	Serial 3 Port Options	
	AUT.OPT		Auto serial transmission subgroup	
		AUTO.TP	Format for auto-transmit data	
		Src	Weight source for auto-transmit	
		Aut.Fmt	User programmable format	
		St.Chr	String start character (ASCII)	
		End.CH1	1 st string end character (ASCII)	
		End.CH2	2 nd string end character (ASCII)	
	Prn.OPT		Printer options subgroup	
		Prnt.tP	Type of printout	
		HdR 1	Entry of custom ticket header line 1	
		HdR 2	Entry of custom ticket header line 2	
		Tic.Fmt	Entry of custom ticket format	
		SPC.COL	Ticket margin column space	
		SPC.RO	Ticket margin row space	
	W			
TEST			Test facilities	8.5
	TEST.IO		Input/Output Tests	
		Frc.Out	Force outputs on setpoint card	
		tSt.InP	Test external inputs (Inputs 1234)	
	AUTO		Display current autobaud settings	
	SCAN		Perform an autobaud operation	
	STAT		Display received data statistics	
	DISPLY		Run a display test	
	TMINAL		Capture and display serial data	
	CFG.FMT		Config. remote display from serial data	

GROUP 	ITEM 	SELECT 	Description	Ref
SET.PTS			Setpoint configuration	8.6
	ACTIVE		Set activity for each setpoint	
	LOC		Set locking of setpoint	
	SRC		Weight source for setpoint	
	DIR		Weight increasing/decreasing	
	LOGIC		Setpoint active high/low	
	ALARM		Setpoint alarm conditions	
	TARGET		Setpoint target weight	
	HYS		Setpoint hysteresis	
	FLT		Setpoint inflight setting	
	FLT.AD		Setpoint inflight adjustment	
AnALoG			Analog combo card settings	8.7
	SRC		Reading source for analogue output	
	TYPE		Voltage or current output	
	CAL.Lo		Fine adjust. of output for zero weight	
	CAL.Hi		Fine adjust. of output for full scale	
	Frc.An1		Testing of analogue output	
CLOC			Time and date settings	8.8
	TIME		Setting of current time	
	dATE		Setting of current date	
FACTRY			Factory settings	8.9
	dEFLT		Restore digital setup to factory settings	
	FAC.RST		Factory access only	
	CONFIG		Enter license codes	

SMART WEIGHING SOLUTIONS



rinstrum